

I/O PRODUCTS

High Speed Pluggable I/O Solutions

Small Form-Factor Pluggable (SFP)

| | |
|--------------------------|------------|
| Connectors | N-2 to N-3 |
| Cable Assemblies | N-7 to N-8 |
| Tranceiver | N-9 |
| EMI Plug | N-9 |
| Stacked Connectors | N-4 to N-6 |

SFP+

| | |
|-------------------------------------|--------------|
| Cages | N-10 |
| Lightpipe Covers | N-11 |
| Stacked Multi-Port Connectors | N-11 to N-14 |
| Cables | N-15 |

| | |
|------------|------|
| GBIC | N-15 |
|------------|------|

| | |
|------------|------|
| QSFP | N-16 |
|------------|------|

| | |
|------------|------|
| XPAK | N-52 |
|------------|------|

Industry Standard I/O Connectors

| | |
|---------------|------|
| PCIe 1X | N-17 |
|---------------|------|

| | |
|--------------|--------------|
| iPass™ | N-18 to N-32 |
|--------------|--------------|

| | |
|-------------|------|
| HDMI* | N-33 |
|-------------|------|

| | |
|--------------------|------|
| DisplayPort† | N-33 |
|--------------------|------|

| | |
|----------------------|--------------|
| IEEE 1394-1395 | N-34 to N-35 |
|----------------------|--------------|

| | |
|-----------|--------------|
| USB | N-35 to N-40 |
|-----------|--------------|

| | |
|-------------------|--------------|
| InfiniBand‡ | N-41 to N-43 |
|-------------------|--------------|

| | |
|-------------|--------------|
| VHDCI | N-53 to N-57 |
|-------------|--------------|

| | |
|------------------------|--------------|
| Micro-Cross™ DVI | N-78 to N-85 |
|------------------------|--------------|

General I/O Connectors

| | |
|-----------------|--------------|
| LaneLink™ | N-44 to N-52 |
|-----------------|--------------|

| | |
|------------------|--------------|
| HandyLink™ | N-57 to N-62 |
|------------------|--------------|

| | |
|------------|--------------|
| LFH™ | N-63 to N-75 |
|------------|--------------|

| | |
|---------------|------|
| DMS-59™ | N-76 |
|---------------|------|

| | |
|------------------------------------|--------------|
| TDP™ Triad Differential Pair | N-76 to N-77 |
|------------------------------------|--------------|

| | |
|--------------------------|--------------|
| Commercial Micro-D | N-86 to N-88 |
|--------------------------|--------------|

| | |
|----------------------|--------------|
| D-Subminiature | N-89 to N-90 |
|----------------------|--------------|

| | |
|-------------------|------|
| Shutter I/O | N-91 |
|-------------------|------|

Cable Assemblies

| | |
|---|--------------|
| High Performance I/O Cable Assemblies | N-92 to N-94 |
|---|--------------|

Visit www.molex.com to access more part numbers and product information, download sales drawings, product specifications, 3D models, place sample requests, and more.

*HDMI is a trademark of HDMI Licensing, LLC

†DisplayPort is a trademark of Video Electronics Standards Association (VESA)

‡InfiniBand is a trademark of the InfiniBand™ Trade Association

0.80mm (.031") Pitch Small Form-Factor Pluggable (SFP/SFP+) Receptacle

74441

Right Angle, SMT

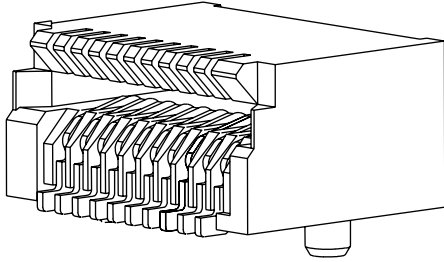

Features and Benefits

- Connector used in conjunction with pluggable transceiver modules allows you to mate copper cable or optical cable assemblies without changing host board
- Card entry slot to accept 1.00mm (.039") thick integrated circuit board (located inside pluggable module)
- Alignment posts provide stability for placement on the PCB
- Standoffs allow easy PCB cleaning after soldering
- SMT receptacle provides option for placement on either side of PCB
- Meets MSA standards

Reference Information

Packaging: Tape and reel
 Mates With: 73929 Copper patch cable, 74720 Copper pluggable module and optical pluggable module
 Use With: 73927 cage assembly
 Designed In: Millimeters

Electrical

Voltage: 30V
 Current: 0.5A
 Contact Resistance: 10 milliohms max.
 Dielectric Withstanding Voltage: 300V AC
 Insulation Resistance: 100 Megohms min.

Mechanical

Contact Retention to Housing: 4.4N (1.0 lb)
 Mating Force: 22N (5.0 lb)
 Unmating Force: 8.8N (2.0 lb)
 Normal Force: 0.8N (80g)
 Durability: 200 cycles

Physical

Housing: High-temperature thermoplastic
 Contact: Copper Alloy
 Plating: Contact Area—See table
 Solder Tail Area—Gold flash or 2.54mm Tin
 Underplating—2.54µm Nickel
 PCB Thickness: 1.00mm (.039")

| Circuits | Order No. | Plating | Version |
|----------|----------------------------|--------------------------------|------------------|
| 20 | 74441-0001 | 0.38µm (25µ") Gold | SFP, SFP+ |
| | 74441-0010 | 0.76µm (30µ") Gold | |
| | 74441-0021 | 0.76µm (30µ") Gold, lubricated | |
| 30 | 74441-0007 | 0.38µm (25µ") Gold | XFP |
| | 74441-0017 | 0.76µm (30µ") Gold | |
| | 74441-0027 | 0.76µm (30µ") Gold, lubricated | |
| 70 | 74441-0003 | 0.38µm (25µ") Gold | Xenpak, X2, XPAK |
| | 74441-0013 | 0.76µm (30µ") Gold | |
| | 74441-0023 | 0.76µm (30µ") Gold, lubricated | |

www.molex.com/product/sfp.html

1X SFP (Small Form-factor Pluggable) EMI Cage

74737

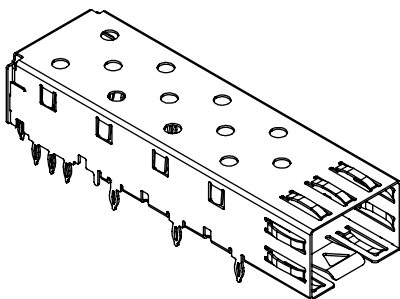

Features and Benefits

- Press-fit, solder post and PCI pin styles enable use with various PCB thicknesses and assembly processes
- Two-point spring contacts offer optimal EMI grounding
- One-piece, stamped and formed cage is able to meet RoHS requirements by eliminating solder
- Built in tabs allow addition of lightpipe cover

Reference Information

Packaging: Tray
 Mates With: 73929, 73930, 74742, 74743 and 74720
 Use With: 74441
 Designed In: Millimeters

Mechanical

Insertion Force to PCB: 3.25 lbf per press-fit pin
 Retention Force to PCB: 1.6 lbf per press-fit pin
 Durability: 1 cycle

Physical

Cage Housing: C770 Alloy
 Plating: Nickel
 PCB Thickness: 1.57mm (.062") min.

| Order No. | Description | Lead-free |
|----------------------------|---|-----------|
| 74737-0004 | Press-fit (.090") legs, Belly-to-Belly | Yes |
| 74737-0009 | Press-fit (.120") legs | |
| 74737-0010 | Solder post (0.133" legs), wave solder for 0.093" PCB | |
| 74737-0012 | Press-fit (.090") legs with 74737-0009 leg style | |
| 74737-0014 | Press-fit (0.120" legs) with Kapton tape | |
| 74737-0016 | | |

Multi-Port SFP (Small Form-factor Pluggable) EMI Cage

74722/74728/74723/74747 Ganged

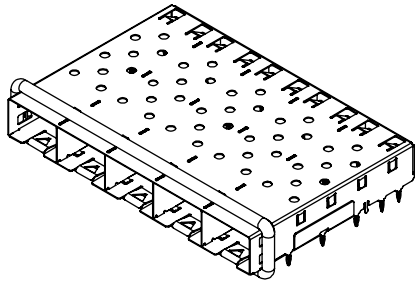

Features and Benefits

- Ganged SFP design offers significant PCB width savings over the single cage solution
- 360° conductive elastomeric gasket and multiple ground pin locations provide advanced shielding to the bezel
- Press-fit pin design accommodates belly-to-belly applications to ensure best use of PCB real estate
- Built in tabs allow addition of ganged lightpipe covers

Reference Information

Packaging: Tray
 Mates With: 73929, 73930, 74742, 74743, 74720
 Use With: 74441 connector and 74726, 74727, 74728, 74729, 74748 lightpipe covers
 Designed In: Millimeters

Mechanical

Durability: 1 cycle

Physical

Cage housing: C770 Alloy
 Plating: Nickel
 PCB Thickness: 1.57mm (.062") min.

| Order No. | Description | Mounting | Lead-free |
|----------------------------|-----------------------------------|-----------|-----------|
| 74722-0001 | 1 by 2 Ganged Cage—Belly to Belly | Press-fit | Yes |
| 74722-0004 | Single Side 1 by 2 | | |
| 74728-0415 | 1 by 4 Ganged Cage—Belly to Belly | | |
| 74728-0420 | Single Side 1 by 4 | | |
| 74723-0001 | 1 by 5 Ganged Cage | | |
| 74747-0001 | 1 by 6 Ganged Cage | | |

SFP (Small Form-factor Pluggable) Lightpipe Covers for Single and Multi-Port EMI Cages

74726/74727/74728/74729/74748

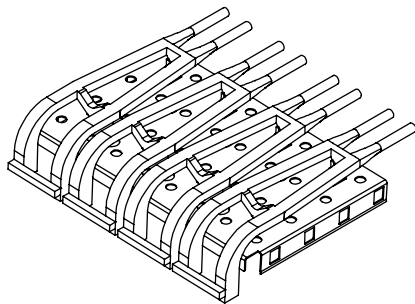

Features and Benefits

- Lightpipes compensate for misalignment and help ensure uniform panel illumination
- Mechanically attaching lightpipes to the lightpipe cover reduces assembly time and eliminates processing issues
- Cage mounted tabs ensure proper cover placement
- Application notes on individual sales drawings help decrease design time and costs by providing recommended LEDs

Reference Information

Packaging: Tray
 Mates With: 74722, 74723, 74728, 74737 and 74747 cages
 Designed In: Millimeters

Mechanical

Durability: 1 cycle—Lightpipes to cover

Physical

Lightpipe: Polycarbonate, UL 94V-0
 Lightpipe Cover: C770 Alloy
 Lightpipe Cover Plating: Nickel

| Order No. | Description | Lightpipe Location* | Lead-free |
|----------------------------|---------------------|---------------------|-----------|
| 74726-0001 | 1 by 1 | Rear Mount | Yes |
| 74726-0002 | | Side Mount | |
| 74727-0001 | 1 by 2 | Rear Mount | |
| 74727-0002 | | Side Mount | |
| 74728-0001 | 1 by 4 | Rear Mount | |
| 74729-0001 | 1 by 5 | | |
| 74748-0001 | 1 by 6 | | |
| 74748-0002 | 1 by 6, low profile | | |

*Note: Low profile lightpipes are available for all rear-mounted locations; shortened lightpipes (by 0.052") are available for rear-mounted locations

0.80mm (.031") Pitch 2-by-1 SFP Stacked Multi-Port Connector

75640/75462

**25.50mm (1.004") Height
With Press-Fit PC Tails
With and Without Lightpipes**

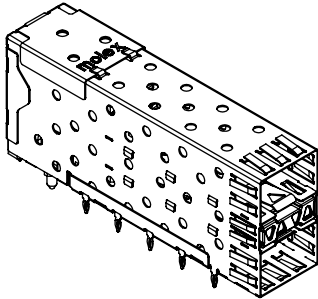

| Order No. | Lightpipes | Tail Plating |
|----------------------------|-------------------|--------------|
| 75640-0001 | 2 per port | Tin/Lead |
| 75640-5001 | | Tin |
| 75640-0002 | 1 per port, inner | Tin/Lead |
| 75640-5002 | | Tin |
| 75640-0003 | 1 per port, outer | Tin/Lead |
| 75640-5003 | | Tin |
| 75462-0001 | None | Tin/Lead |
| 75462-5001 | | Tin |

Note: Please refer to sales drawing for footprint differences between versions with and without lightpipes.

Features and Benefits

- Integrates 2 SFP ports and LED lightpipes into 1 connector
- Press-fit termination to PCB
- Fully shielded for EMI protection
- Lightpipes for port status and activity feedback

Reference Information

Product Specification: PS-75310-001
 Packaging: Tray
 UL File No.: E29179
 CSA File No.: LR19980
 Mates With: SFP transceivers or cables
 Designed In: Millimeters

Electrical

Voltage: 30V
 Current: 0.5A max.
 Contact Resistance: 10 milliohms max.
 Dielectric Withstanding Voltage: 300V AC
 Insulation Resistance: 100 Megohms min.

Mechanical

Mating Force: 40N max.
 Unmating Force: 11.5N max.
 Durability: 200 cycles

Physical

Housing: Thermoplastic
 Contact: Copper Alloy
 Plating: Contact Area—Gold
 Tail Area—See table
 Underplating—Nickel
 PCB Thickness: 2.40mm (.093")

0.80mm (.031") Pitch 2-by-1 SFP Stacked Multi-Port Connector

75310/75786

**29.30mm (1.153") Height
With Lightpipes**

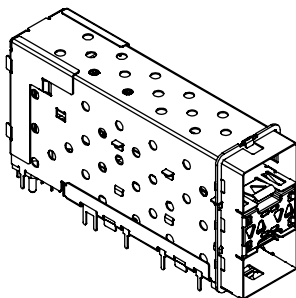

| Order No. | PC Tail | Tail Plating | Lead-free |
|----------------------------|-----------|--------------|-----------|
| 75310-0001 | Solder | Tin | Yes |
| 75786-0001 | Press-Fit | Tin-Lead | No |
| 75786-5001 | | Tin | Yes |

Features and Benefits

- Integrates 2 SFP ports and LED lightpipes into 1 connector
- Design capable of transmission speeds well beyond the 4.25 Gbps Next Generation Fibre Channel interface
- Fully shielded with gasket for EMI protection
- Lightpipes for port status and activity feedback

Reference Information

Product Specification: PS-75310-001
 Packaging: Tray
 UL File No.: E29179
 CSA File No.: LR19980
 Mates With: SFP Transceivers or Cables
 Designed In: Millimeters

Electrical

Voltage: 30V
 Current: 0.5A max
 Contact Resistance: 10 milliohms max.
 Dielectric Withstanding Voltage: 300V AC
 Insulation Resistance: 100 Megohms min.

Mechanical

Mating Force: 40N max
 Unmating Force: 11.5N max
 Durability: 200 cycles

Physical

Housing: Thermoplastic
 Contact: Copper Alloy
 Plating: Contact Area—Gold
 Tail Area—See table
 Underplating—Nickel
 PCB Thickness: 2.40mm (.093")

0.80mm (.031") Pitch 2-by-2 SFP Stacked Multi-Port Connector

75714/75759

**25.50mm (1.004") Height
With Press-Fit PC Tails
With and Without Lightpipes**

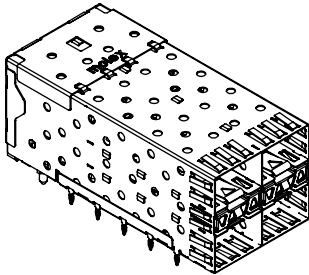

| Order No. | Lightpipes | Tail Plating |
|----------------------------|-------------------|--------------|
| 75714-0001 | 2 per port | Tin/Lead |
| 75714-5001 | | Tin |
| 75714-0002 | 1 per port, inner | Tin/Lead |
| 75714-5002 | | Tin |
| 75714-0003 | 1 per port, outer | Tin/Lead |
| 75714-5003 | | Tin |
| 75759-0001 | None | Tin/Lead |
| 75759-5001 | | Tin |

Note: Please refer to sales drawing for footprint differences between versions with and without lightpipes.

Features and Benefits

- Integrates 4 SFP ports and LED lightpipes into 1 connector
- Press-fit termination to PCB
- Fully shielded for EMI protection
- Lightpipes for port status and activity feedback

Reference Information

Product Specification: PS-75310-001
Packaging: Tray
UL File No.: E29179
CSA File No.: LR19980
Mates With: SFP transceivers or cables
Designed In: Millimeters

Electrical

Voltage: 30V
Current: 0.5A max.
Contact Resistance: 10 milliohms max.
Dielectric Withstanding Voltage: 300V AC
Insulation Resistance: 100 Megohms min.

Mechanical

Mating Force: 40N max.
Unmating Force: 11.5N max.
Durability: 200 cycles

Physical

Housing: Thermoplastic
Contact: Copper Alloy
Plating: Contact Area—Gold
Tail Area—See table
Underplating—Nickel
PCB Thickness: 2.40mm (.093")

0.80mm (.031") Pitch 2-by-4 SFP Stacked Multi-Port Connector

75450/75454

**25.50mm (1.004") Height
With Press-Fit PC Tails
With and Without Lightpipes**

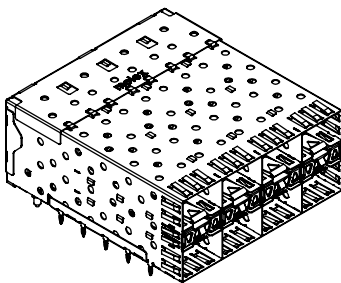

| Order No. | Lightpipes | Tail Plating |
|----------------------------|-------------------|--------------|
| 75450-0001 | 2 per port | Tin/Lead |
| 75450-5001 | | Tin |
| 75450-0002 | 1 per port, inner | Tin/Lead |
| 75450-5002 | | Tin |
| 75450-0003 | 1 per port, outer | Tin/Lead |
| 75450-5003 | | Tin |
| 75454-0001 | None | Tin/Lead |
| 75454-5001 | | Tin |

Note: Please refer to sales drawing for footprint differences between versions with and without lightpipes.

Features and Benefits

- Integrates 8 SFP ports and LED lightpipes into 1 connector
- Press-fit termination to PCB
- Fully shielded for EMI protection
- Lightpipes for port status and activity feedback

Reference Information

Product Specification: PS-75310-001
Packaging: Tray
UL File No.: E29179
CSA File No.: LR19980
Mates With: SFP transceivers or cables
Designed In: Millimeters

Electrical

Voltage: 30V
Current: 0.5A max.
Contact Resistance: 10 milliohms max.
Dielectric Withstanding Voltage: 300V AC
Insulation Resistance: 100 Megohms min.

Mechanical

Mating Force: 40N max.
Unmating Force: 11.5N max.
Durability: 200 cycles

Physical

Housing: Thermoplastic
Contact: Copper Alloy
Plating: Contact Area—Gold
Tail Area—See table
Underplating—Nickel
PCB Thickness: 2.40mm (.093")

0.80mm (.031") Pitch 2-by-5 SFP Stacked Multi-Port Connector

75734/75733

**25.50mm (1.004") Height
With Press-Fit PC Tails
With and Without Lightpipes**

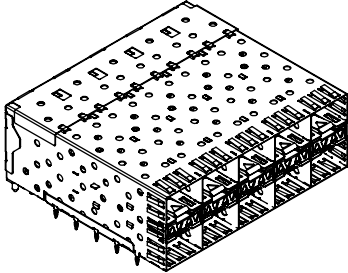

| Order No. | Lightpipes | Tail Plating |
|----------------------------|-------------------|--------------|
| 75734-0001 | 2 per port | Tin/Lead |
| 75734-5001 | | Tin |
| 75734-0002 | 1 per port, inner | Tin/Lead |
| 75734-5002 | | Tin |
| 75734-0003 | 1 per port, outer | Tin/Lead |
| 75734-5003 | | Tin |
| 75733-0001 | None | Tin/Lead |
| 75733-0001 | | Tin |

Note: Please refer to sales drawing for footprint differences between versions with and without lightpipes.

Features and Benefits

- Integrates 10 SFP ports and LED lightpipes into 1 connector
- Press-fit termination to PCB
- Fully shielded for EMI protection
- Lightpipes for port status and activity feedback

Reference Information

Product Specification: PS-75310-001
Packaging: Tray
UL File No.: E29179
CSA File No.: LR19980
Mates With: SFP transceivers or cables
Designed In: Millimeters

Electrical

Voltage: 30V
Current: 0.5A max.
Contact Resistance: 10 milliohms max.
Dielectric Withstanding Voltage: 300V AC
Insulation Resistance: 100 Megohms min.

Mechanical

Mating Force: 40N max.
Unmating Force: 11.5N max.
Durability: 200 cycles

Physical

Housing: Thermoplastic
Contact: Copper Alloy
Plating: Contact Area—Gold
Tail Area—See table
Underplating—Nickel
PCB Thickness: 2.40mm (.093")

0.80mm (.031") Pitch 2-by-6 SFP Stacked Multi-Port Connector

75451/75477

**25.50mm (1.004") Height
With Press-Fit PC Tails
With and Without Lightpipes**

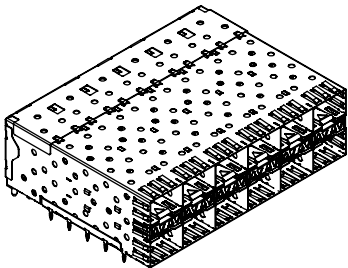

| Order No. | Lightpipes | Tail Plating |
|----------------------------|-------------------|--------------|
| 75451-0001 | 2 per port | Tin/Lead |
| 75451-5001 | | Tin |
| 75451-0002 | 1 per port, inner | Tin/Lead |
| 75451-5002 | | Tin |
| 75451-0003 | 1 per port, outer | Tin/Lead |
| 75451-5003 | | Tin |
| 75477-0001 | None | Tin/Lead |
| 75477-0001 | | Tin |

Note: Please refer to sales drawing for footprint differences between versions with and without lightpipes.

Features and Benefits

- Integrates 12 SFP ports and LED lightpipes into 1 connector
- Press-fit termination to PCB
- Fully shielded for EMI protection
- Lightpipes for port status and activity feedback

Reference Information

Product Specification: PS-75310-001
Packaging: Tray
UL File No.: E29179
CSA File No.: LR19980
Mates With: SFP transceivers or cables
Designed In: Millimeters

Electrical

Voltage: 30V
Current: 0.5A max.
Contact Resistance: 10 milliohms max.
Dielectric Withstanding Voltage: 300V AC
Insulation Resistance: 100 Megohms min.

Mechanical

Mating Force: 40N max.
Unmating Force: 11.5N max.
Durability: 200 cycles

Physical

Housing: Thermoplastic
Contact: Copper Alloy
Plating: Contact Area—Gold
Tail Area—See table
Underplating—Nickel
PCB Thickness: 2.40mm (.093")

1.27mm (.050") Pitch SFP (Small Form-Factor Pluggable) Copper Cable Assembly

73929

Passive

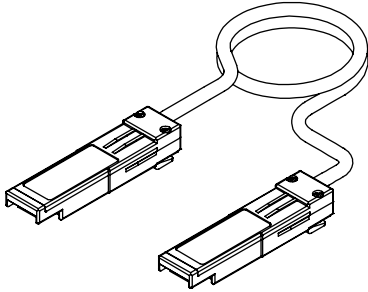

Features and Benefits

- Compliant with SFP MSA
- Fibre Channel data rates to 2.125 Gbps
- Gigabit Ethernet data rates to 2.5 Gbps
- InfiniBand* data rates to 2.5 Gbps
- Hot pluggable
- Intuitive “squeeze and pull” latching mechanism
- Supports Serial ID functionality

Reference Information

Packaging: Bag and box
 UL File No.: E72548 vol. 1C
 Mates With: 74441
 Use With: 73927, 74722, 74728, 74729, 74737
 and 74748
 Designed In: Millimeters

Electrical

Voltage: 3.3V
 Current: Passive—30mA max.
 Active—175mA max.

Mechanical

Durability: 250 cycles

Physical

Housing: Zinc diecast
 Contact: Gold flash
 Housing Plating: Nickel

| Length | Order No. | Circuitry | Lead-free |
|---------------|----------------------------|-----------|-----------|
| 1.0m (3.28') | 73929-0001 | Passive | Yes |
| 3.0m (9.84') | 73929-0002 | | |
| 5.0m (16.40') | 73929-0003 | | |
| 2.0m (6.56') | 73929-0006 | | |
| 0.5m (1.64') | 73929-0011 | | |

* InfiniBand is a trademark of the InfiniBand Trade Association.

4 Gbps SFP (Small Form-factor Pluggable) Copper Cable Assembly

74742

Passive

74743

Active

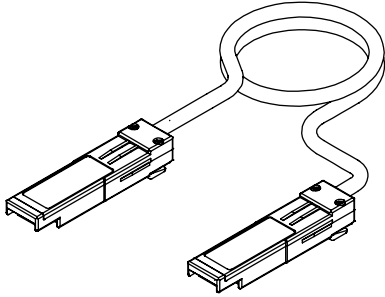

Features and Benefits

- Improved PCB design helps match impedance to reduce reflection at higher speeds
- Serial ID allows serial identification of each SFP transceiver
- Compliant with SFP MSA and designed to meet FC, IB and GE standards
- Unique thumb latch provides intuitive squeeze and pull latching mechanism

Reference Information

Packaging: Bag
 UL File No.: E72548 vol. 1C
 Mates With: 74441
 Use With: 73927, 74722, 74723, 74728, 74737 and 74747
 Designed In: Millimeters

Electrical

Voltage: 3.3V
 Current: Passive—30mA max.
 Active—175mA max.

Mechanical

Durability: 250 cycles

Physical

Housing: Zinc diecast
 Housing Plating: Nickel
 PCB Contact: Gold

I/O Products

N

| Length | Order No. | Circuitry | Lead-free |
|----------------|----------------------------|-----------|-----------|
| 1.0m (3.28') | 74742-0001 | Passive | Yes |
| 2.0m (6.56') | 74742-0002 | | |
| 3.0m (9.84') | 74742-0003 | | |
| 1.0m (3.28') | 74743-0001 | Active | |
| 2.0m (6.56') | 74743-0002 | | |
| 3.0m (9.84') | 74743-0003 | | |
| 4.0m (13.12') | 74743-0004 | | |
| 5.0m (16.40') | 74743-0005 | | |
| 6.0m (19.68') | 74743-0006 | | |
| 7.0m (22.97') | 74743-0007 | | |
| 8.0m (26.25') | 74743-0008 | | |
| 9.0m (29.53') | 74743-0009 | | |
| 10.0m (32.80') | 74743-0010 | | |
| 11.0m (36.09') | 74743-0011 | | |
| 12.0m (39.37') | 74743-0012 | | |
| 13.0m (42.65') | 74743-0013 | | |
| 14.0m (45.93') | 74743-0014 | | |
| 15.0m (49.51') | 74743-0015 | | |

1000 BaseT RJ-45 SFP (Small Form-Factor Pluggable) Copper Transceiver

74741

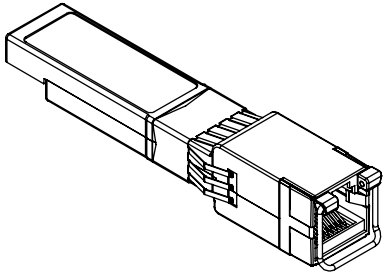

| Order No. | Options | Lead-free |
|----------------------------|---------------------------------|-----------|
| 74741-0005 | Auto Negotiation On, LOS GRD | Yes |
| 74741-0006 | Auto Negotiation On, LOS Toggle | |

Features and Benefits

- 1000 Base-T compliant, meets IEEE802.3z, ab
- SFP MSA compliant
- Hot pluggable, eliminating the need to power down to remove or install
- Auto negotiation software selectable
- Side-to-Side latching for increased density
- Serial ID allows individual identification of each SFP transceiver

Reference Information

Packaging: Bag
Mates With: 74441
Use With: 74737 and 73927
Designed In: Millimeters

Electrical

Voltage: 3.3V
Current: 285mA

Mechanical

Transceiver Retention to Cage: 90N min.
Mating Force: <9N nom.
Unmating Force: <9N nom.
Durability: 50 cycles

Physical

Housing: Zinc diecast
Housing Plating: Nickel
PCB Thickness: 1.0mm (.039")

SFP (Small Form-factor Pluggable) EMI plug

74720

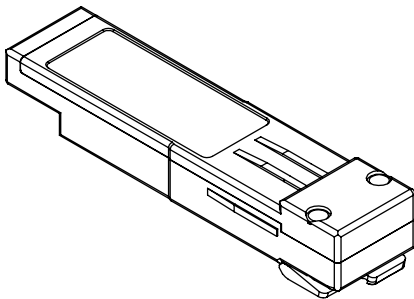

| Order No. | Lead-free |
|----------------------------|-----------|
| 74720-0510 | Yes |

Features and Benefits

- Mates to components which are compliant with SFP MSA mechanical specifications
- Raised plug wedges assure electrical contact with surrounding SFP EMI cage
- Diecast housing provides superior EMI performance
- Spring-loaded latch releases with simple squeeze and pull action

Reference Information

Packaging: Tray
Use With: 73927, 74722, 74723, 74728, 74729, 74737
and 74747 SFP cage series
Designed In: Millimeters

Mechanical

Durability: 250 cycles

Physical

Housing: Zinc diecast
Plating: Nickel

SFP+ Cage

74754 Single Port

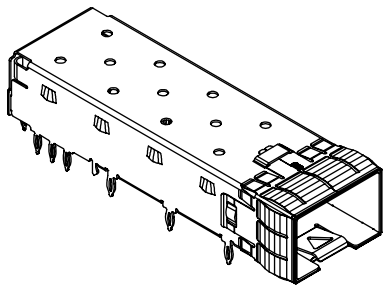

Features and Benefits

- Press-fit, solder post and PCI pin styles enable use with various PCB thicknesses and assembly processes
- One piece stamped and formed cage is able to meet RoHS requirements by eliminating solder
- Newly designed spring finger gasket provides optimal EMI grounding

Reference Information

Packaging: Tray
 Mates With: 74754 cable and 74763 loopback
 Use With: 74441 connector
 Designed In: Millimeters

Mechanical

Durability: 1 cycle

Physical

Housing: Copper Alloy
 Plating: Nickel
 PCB Thickness: 1.57mm (.062") min.

| Order No. | Pin/Leg Style | Pin/Leg Length | Lead-free |
|----------------------------|----------------------------|----------------|-----------|
| 74754-0101 | Press Fit | 3.05 (.120) | Yes |
| 74754-0102 | Press Fit (Belly-to-belly) | 2.29 (.090) | |
| 74754-0103 | Solder Post | 3.38 (.133) | |
| 74754-0104 | Press Fit | 3.05 (.120) | |
| 74754-0105 | Press Fit | 3.05 (.120) | |
| 74754-0106 | Solder Post | PCI | |

SFP+ Cage

74754 Ganged

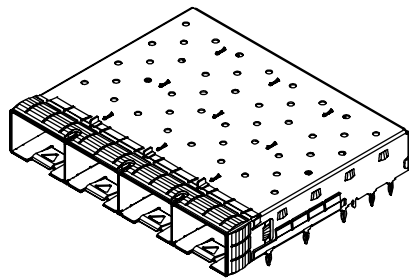

Features and Benefits

- Newly designed spring finger gaskets offer optimal EMI grounding
- 360° gaskets and underbelly EMI fingers provide multiple points of contact to break up EMI
- Ganged SFP design offers significant PCB width savings over single cage solutions
- Ganged cages accommodate belly-to-belly applications for best use of PCB real estate

Reference Information

Packaging: Tray
 Mates With: 74754 and 74765
 Use With: 74441 connector and 74754 lightpipe covers
 Designed In: Millimeters

Mechanical

Durability: 1 cycle

Physical

Cage housing: Copper Alloy
 Plating: Nickel
 PCB Thickness: 1.57mm (.062") min.

| Order No. | Port Size | Bezel Gasket Material | Mounting | Lead-free |
|----------------------------|-----------|-----------------------|----------------|-----------|
| 74754-0210 | 1 by 2 | Elastomer | Press fit pins | Yes |
| 74754-0220 | | Metal spring fingers | | |
| 74754-0410 | 1 by 4 | Elastomer | | |
| 74754-0420 | | Metal spring fingers | | |
| 74754-0510 | 1 by 5 | Elastomer | | |
| 74754-0520 | | Metal spring fingers | | |
| 74754-0610 | 1 by 6 | Elastomer | | |
| 74754-0620 | | Metal spring fingers | | |

SFP+ Lightpipe Covers

74754

For Single and Multiport EMI Cages Low Profile

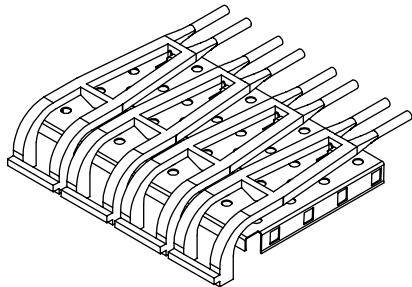

Features and Benefits

- Lightpipes compensate for misalignment and help ensure uniform panel illumination
- Mechanically attaching lightpipes to the lightpipe cover reduces assembly time and eliminates processing issues
- Cage mounted tabs ensure proper cover placement

Reference Information

Packaging: Tray
Mates With: 74754 cages
Designed In: Millimeters

Mechanical

Durability: 1 cycle—Lightpipe to cover

Physical

Lightpipe: UL 94V-0
Lightpipe Cover: Copper Alloy
Lightpipe Cover Plating: Nickel

| Order No. | Description | Lightpipe Location | Lead-free |
|----------------------------|-------------|--------------------|-----------|
| 74754-0011 | 1 by 1 | Rear Mount | Yes |
| 74754-0021 | 1 by 2 | | |
| 74754-0041 | 1 by 4 | | |
| 74754-0051 | 1 by 5 | | |
| 74754-0061 | 1 by 6 | | |

0.80mm (.031") Pitch 2-by-1 SFP+ Stacked Multi-Port Connector

76090/76100/76044/76064

Press-Fit, Metal or Elastomeric Gasket

With and without Lightpipes

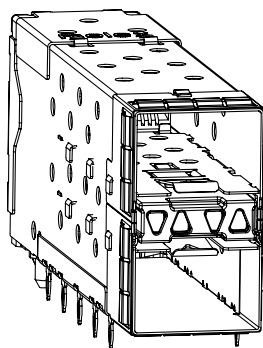

Features and Benefits

- Integrates 2 SFP ports and LED lightpipes into 1 connector
- Press-fit termination to PCB
- Fully shielded for EMI protection
- Lightpipes for port status and activity feedback

Reference Information

Product Specification: PS-75310-001
Packaging: Tray
UL File No.: E29179
CSA File No.: LR19980
Mates With: SFP transceivers or cables
Designed In: Millimeters

Electrical

Voltage: 30V
Current: 0.5A max.
Contact Resistance: 10 milliohms max.
Dielectric Withstanding Voltage: 300V AC
Insulation Resistance: 100 Megohms min.

Mechanical

Mating Force: 40N max.
Unmating Force: 11.5N max.
Durability: 200 cycles

Physical

Housing: Thermoplastic
Contact: Copper Alloy
Plating: Contact Area—Gold
Tail Area—See table
Underplating—Nickel
PCB Thickness: 2.40mm (.093")

Elastomeric Gasket

| Order No. | Lightpipes | Tail Plating |
|----------------------------|-------------------|--------------|
| 76090-0001 | 2 per port | Tin/Lead |
| 76090-5001 | | Tin |
| 76090-0002 | 1 per port, inner | Tin/Lead |
| 76090-5002 | | Tin |
| 76090-0003 | 1 per port, outer | Tin/Lead |
| 76090-5003 | | Tin |
| 76100-0001 | None | Tin/Lead |
| 76100-5001 | None | Tin |

Metal Gasket

| Order No. | Lightpipes | Tail Plating |
|----------------------------|-------------------|--------------|
| 76044-0001 | 2 per port | Tin/Lead |
| 76044-5001 | | Tin |
| 76044-0002 | 1 per port, inner | Tin/Lead |
| 76044-5002 | | Tin |
| 76044-0003 | 1 per port, outer | Tin/Lead |
| 76044-5003 | | Tin |
| 76064-0001 | None | Tin/Lead |
| 76064-5001 | None | Tin |

Note: Please refer to sales drawing for footprint differences between versions with and without lightpipes

0.80mm (.031") Pitch 2-by-2 SFP+ Stacked Multi-Port Connector

76091/76101/76045/76065
Press-Fit, Metal or Elastomeric
Gasket
With and without Lightpipes

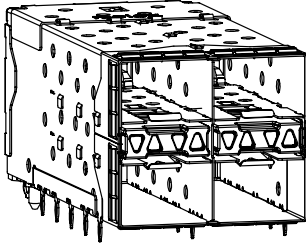

Features and Benefits

- Integrates 4 SFP ports and LED lightpipes into 1 connector
- Press-fit termination to PCB
- Fully shielded for EMI protection
- Lightpipes for port status and activity feedback

Reference Information

Product Specification: PS-75310-001
Packaging: Tray
UL File No.: E29179
CSA File No.: LR19980
Mates With: SFP transceivers or cables
Designed In: Millimeters

Electrical

Voltage: 30V
Current: 0.5A max.
Contact Resistance: 10 milliohms max.
Dielectric Withstanding Voltage: 300V AC
Insulation Resistance: 100 Megohms min.

Mechanical

Mating Force: 40N max.
Unmating Force: 11.5N max.
Durability: 200 cycles

Physical

Housing: Thermoplastic
Contact: Copper Alloy
Plating: Contact Area—Gold
Tail Area—See table
Underplating—Nickel
PCB Thickness: 2.40mm (.093")

Elastomeric Gasket

| Order No. | Lightpipes | Tail Plating |
|----------------------------|-------------------|--------------|
| 76091-0001 | 2 per port | Tin/Lead |
| 76091-5001 | | Tin |
| 76091-0002 | 1 per port, inner | Tin/Lead |
| 76091-5002 | | Tin |
| 76091-0003 | 1 per port, outer | Tin/Lead |
| 76091-5003 | | Tin |
| 76101-0001 | None | Tin/Lead |
| 76101-5001 | None | Tin |

Metal Gasket

| Order No. | Lightpipes | Tail Plating |
|----------------------------|-------------------|--------------|
| 76045-0001 | 2 per port | Tin/Lead |
| 76045-5001 | | Tin |
| 76045-0002 | 1 per port, inner | Tin/Lead |
| 76045-5002 | | Tin |
| 76045-0003 | 1 per port, outer | Tin/Lead |
| 76045-5003 | | Tin |
| 76065-0001 | None | Tin/Lead |
| 76065-5001 | None | Tin |

Note: Please refer to sales drawing for footprint differences between versions with and without lightpipes

0.80mm (.031") Pitch 2-by-4 SFP+ Stacked Multi-Port Connector

76092/76102/76046/76066
Press-Fit, Metal or Elastomeric
Gasket
With and without Lightpipes

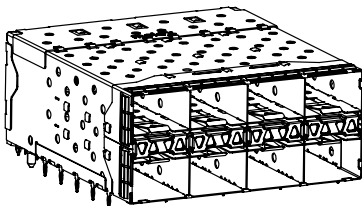

Features and Benefits

- Integrates 8 SFP ports and LED lightpipes into 1 connector
- Press-fit termination to PCB
- Fully shielded for EMI protection
- Lightpipes for port status and activity feedback

Reference Information

Product Specification: PS-75310-001
Packaging: Tray
UL File No.: E29179
CSA File No.: LR19980
Mates With: SFP transceivers or cables
Designed In: Millimeters

Electrical

Voltage: 30V
Current: 0.5A max.
Contact Resistance: 10 milliohms max.
Dielectric Withstanding Voltage: 300V AC
Insulation Resistance: 100 Megohms min.

Mechanical

Mating Force: 40N max.
Unmating Force: 11.5N max.
Durability: 200 cycles

Physical

Housing: Thermoplastic
Contact: Copper Alloy
Plating: Contact Area—Gold
Tail Area—See table
Underplating—Nickel
PCB Thickness: 2.40mm (.093")

Elastomeric Gasket

| Order No. | Lightpipes | Tail Plating |
|----------------------------|-------------------|--------------|
| 76092-0001 | 2 per port | Tin/Lead |
| 76092-5001 | | Tin |
| 76092-0002 | 1 per port, inner | Tin/Lead |
| 76092-5002 | | Tin |
| 76092-0003 | 1 per port, outer | Tin/Lead |
| 76092-5003 | | Tin |
| 76102-0001 | None | Tin/Lead |
| 76102-5001 | None | Tin |

Metal Gasket

| Order No. | Lightpipes | Tail Plating |
|----------------------------|-------------------|--------------|
| 76046-0001 | 2 per port | Tin/Lead |
| 76046-5001 | | Tin |
| 76046-0002 | 1 per port, inner | Tin/Lead |
| 76046-5002 | | Tin |
| 76046-0003 | 1 per port, outer | Tin/Lead |
| 76046-5003 | | Tin |
| 76066-0001 | None | Tin/Lead |
| 76066-5001 | None | Tin |

Note: Please refer to sales drawing for footprint differences between versions with and without lightpipes

0.80mm (.031") Pitch 2-by-5 SFP+ Stacked Multi-Port Connector

76093/76103/76047/76067
Press-Fit, Metal or Elastomeric
Gasket
With and without Lightpipes

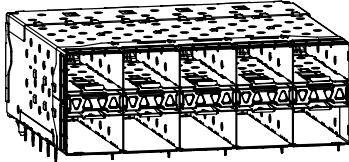

Features and Benefits

- Integrates 10 SFP ports and LED lightpipes into 1 connector
- Press-fit termination to PCB
- Fully shielded for EMI protection
- Lightpipes for port status and activity feedback

Reference Information

Product Specification: PS-75310-001
Packaging: Tray
UL File No.: E29179
CSA File No.: LR19980
Mates With: SFP transceivers or cables
Designed In: Millimeters

Electrical

Voltage: 30V
Current: 0.5A max.
Contact Resistance: 10 milliohms max.
Dielectric Withstanding Voltage: 300V AC
Insulation Resistance: 100 Megohms min.

Mechanical

Mating Force: 40N max.
Unmating Force: 11.5N max.
Durability: 200 cycles

Physical

Housing: Thermoplastic
Contact: Copper Alloy
Plating: Contact Area—Gold
Tail Area—See table
Underplating—Nickel
PCB Thickness: 2.40mm (.093")

Elastomeric Gasket

| Order No. | Lightpipes | Tail Plating |
|----------------------------|-------------------|--------------|
| 76093-0001 | 2 per port | Tin/Lead |
| 76093-5001 | | Tin |
| 76093-0002 | 1 per port, inner | Tin/Lead |
| 76093-5002 | | Tin |
| 76093-0003 | 1 per port, outer | Tin/Lead |
| 76093-5003 | | Tin |
| 76103-0001 | None | Tin/Lead |
| 76103-5001 | None | Tin |

Note: Please refer to sales drawing for footprint differences between versions with and without lightpipes

Metal Gasket

| Order No. | Lightpipes | Tail Plating |
|----------------------------|-------------------|--------------|
| 76047-0001 | 2 per port | Tin/Lead |
| 76047-5001 | | Tin |
| 76047-0002 | 1 per port, inner | Tin/Lead |
| 76047-5002 | | Tin |
| 76047-0003 | 1 per port, outer | Tin/Lead |
| 76047-5003 | | Tin |
| 76067-0001 | None | Tin/Lead |
| 76067-5001 | None | Tin |

0.80mm (.031") Pitch 2-by-6 SFP+ Stacked Multi-Port Connector

76094/76104/76048/76068
Press-Fit, Metal or Elastomeric
Gasket
With and without Lightpipes

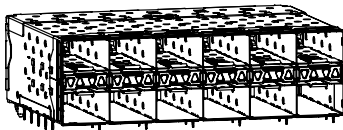

Features and Benefits

- Integrates 12 SFP ports and LED lightpipes into 1 connector
- Press-fit termination to PCB
- Fully shielded for EMI protection
- Lightpipes for port status and activity feedback

Reference Information

Product Specification: PS-75310-001
Packaging: Tray
UL File No.: E29179
CSA File No.: LR19980
Mates With: SFP transceivers or cables
Designed In: Millimeters

Electrical

Voltage: 30V
Current: 0.5A max.
Contact Resistance: 10 milliohms max.
Dielectric Withstanding Voltage: 300V AC
Insulation Resistance: 100 Megohms min.

Mechanical

Mating Force: 40N max.
Unmating Force: 11.5N max.
Durability: 200 cycles

Physical

Housing: Thermoplastic
Contact: Copper Alloy
Plating: Contact Area—Gold
Tail Area—See table
Underplating—Nickel
PCB Thickness: 2.40mm (.093")

Elastomeric Gasket

| Order No. | Lightpipes | Tail Plating |
|----------------------------|-------------------|--------------|
| 76094-0001 | 2 per port | Tin/Lead |
| 76094-5001 | | Tin |
| 76094-0002 | 1 per port, inner | Tin/Lead |
| 76094-5002 | | Tin |
| 76094-0003 | 1 per port, outer | Tin/Lead |
| 76094-5003 | | Tin |
| 76104-0001 | None | Tin/Lead |
| 76104-5001 | None | Tin |

Note: Please refer to sales drawing for footprint differences between versions with and without lightpipes

Metal Gasket

| Order No. | Lightpipes | Tail Plating |
|----------------------------|-------------------|--------------|
| 76048-0001 | 2 per port | Tin/Lead |
| 76048-5001 | | Tin |
| 76048-0002 | 1 per port, inner | Tin/Lead |
| 76048-5002 | | Tin |
| 76048-0003 | 1 per port, outer | Tin/Lead |
| 76048-5003 | | Tin |
| 76068-0001 | None | Tin/Lead |
| 76068-5001 | None | Tin |

0.80mm (.031") Pitch 2-by-8 SFP+ Stacked Multi-Port Connector

76352

**Press-Fit, Metal Gasket
With Lightpipes**

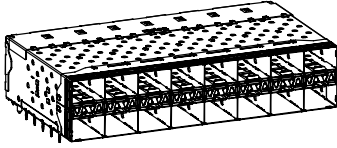

Features and Benefits

- Integrates 16 SFP ports and LED lightpipes into 1 connector
- Press-fit termination to PCB
- Fully shielded for EMI protection
- Lightpipes for port status and activity feedback

Reference Information

Product Specification: PS-75310-001

Packaging: Tray

UL File No.: E29179

CSA File No.: LR19980

Mates With: SFP transceivers or cables

Designed In: Millimeters

Electrical

Voltage: 30V

Current: 0.5A max.

Contact Resistance: 10 milliohms max.

Dielectric Withstanding Voltage: 300V AC

Insulation Resistance: 100 Megohms min.

Mechanical

Mating Force: 40N max.

Unmating Force: 11.5N max.

Durability: 200 cycles

Physical

Housing: Thermoplastic

Contact: Copper Alloy

Plating: Contact Area—Gold

Tail Area—See table

Underplating—Nickel

PCB Thickness: 2.40mm (.093")

| Order No. | Lightpipes | Tail Plating |
|----------------------------|-------------------|--------------|
| 76352-0001 | 2 per port | Tin/Lead |
| 76352-5001 | | Tin |
| 76352-0002 | 1 per port, inner | Tin/Lead |
| 76352-5002 | | Tin |
| 76352-0003 | 1 per port, outer | Tin/Lead |
| 76352-5003 | | Tin |

Note: Please refer to sales drawing for footprint differences between versions with and without lightpipes

0.80mm (.031") Pitch SFP+ Cables

74752 Copper Patch Cables

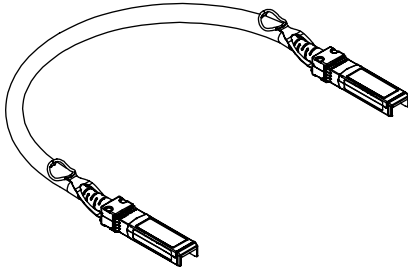

Features and Benefits

- Copper cable data transmission meets customer requirements for speeds up to 10 Gbps and up to 20 meters
- Redesigned pull latch enables belly-to-belly cable use
- Identical dimensions to SFP enable backwards compatibility
- EMI girdle provides superior EMI performance

Reference Information

Packaging: Box
 Mates With: 74441
 Use With: 74754, 76044, 76045, 76046, 76047, 76048, 76090, 76091, 76092, 76093 and 76094
 Designed In: Millimeters

Electrical

Voltage: 3.3V
 Current: 30mA max.

Mechanical

Durability: 250 cycles

Physical

Housing: Zinc die cast
 Plating: Nickel
 PCB contact: Gold

| Order No. | Length | Cable Gauge | Lead-free |
|----------------------------|---------------|-------------|-----------|
| 74752-1051 | 0.50m (1.64') | 30 | Yes |
| 74752-1101 | 1.0m (3.28') | | |
| 74752-1301 | 3.0m (9.84') | | |
| 74752-1501 | 5.0m (16.40') | | |
| 74752-1701 | 7.0m (22.96') | | |
| 74752-2051 | 0.50m (1.64') | 28 | |
| 74752-2101 | 1.0m (3.28') | | |
| 74752-2301 | 3.0m (9.84') | | |
| 74752-2501 | 5.0m (16.40') | | |
| 74752-2701 | 7.0m (22.96') | | |

| Order No. | Length | Cable Gauge | Lead-free |
|----------------------------|---------------|-------------|-----------|
| 74752-3051 | 0.50m (1.64') | 26 | Yes |
| 74752-3101 | 1.0m (3.28') | | |
| 74752-3301 | 3.0m (9.84') | | |
| 74752-3501 | 5.0m (16.40') | | |
| 74752-3701 | 7.0m (22.96') | | |
| 74752-4051 | 0.50m (1.64') | 24 | |
| 74752-4101 | 1.0m (3.28') | | |
| 74752-4301 | 3.0m (9.84') | | |
| 74752-4501 | 5.0m (16.40') | | |
| 74752-4701 | 7.0m (22.96') | | |

Passive cables available in lengths up to 20m depending on cable gauge

www.molex.com/product/sfp-plus.html

1000 BaseT RJ-45 GBIC Copper Transceiver

74740

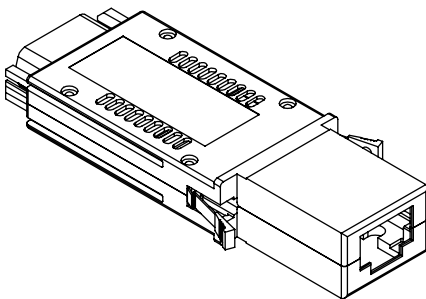

Features and Benefits

- 1000 Base-T compliant, meets IEEE802.3z, ab
- GBIC SFF-8053 Rev 5.5 compliant for improved intermatibility
- Hot pluggable, eliminating the need to power down to remove or install
- Auto negotiation software selectable
- Link monitor detects loss of signal
- Serial ID allows individual identification of each GBIC transceiver

Reference Information

Packaging: Bag
 Mates With: 74065
 Use With: 73847
 Designed In: Millimeters

Electrical

Voltage: 5V
 Current: 350mA

Mechanical

Durability: 250 cycles

Physical

Housing: Zinc diecast
 Housing Plating: Nickel
 PCB Thickness: 1.57mm (.062")

| Order No. | Options | Lead-free |
|----------------------------|----------------------------------|-----------|
| 74740-0001 | Auto Negotiation On, LOS GRD | Yes |
| 74740-0002 | Auto Negotiation On, LOS Toggle | |
| 74740-0003 | Auto Negotiation Off, LOS Toggle | |

QSFP Cages

74750 EMI Cage

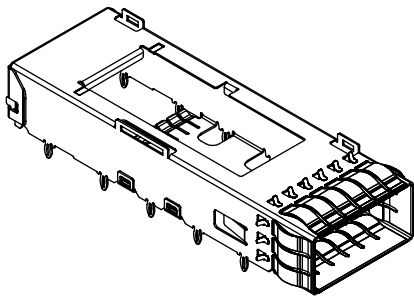

Features and Benefits

- MSA QSFP cages accept copper cables and fiber optic modules
- Spring finger and elastomer gasket options offer design flexibility and optimal EMI grounding
- Blocking keys prevent mis-mating by XFP modules

Reference Information

Packaging: Tray
 Mates With: 74757 and 74763
 Use With: 75586
 Designed In: Millimeters

Mechanical

Insertion Force to PCB: 100 lbf max.
 Durability: 1 cycle

Physical

Housing: Copper Alloy
 Plating: Nickel

| Cages | | | |
|----------------------------|-------------------|--------------------|-----------|
| Order No. | Gasket Style | Pin Placement | Lead-free |
| 74750-0021 | EMI Spring Finger | Two rear press fit | Yes |
| 74750-0022 | Elastomer | | |
| 74750-0023 | EMI Spring Finger | No rear pins | |
| 74750-0025 | Elastomer | | |

| Light Pipes | |
|----------------------------|-------------------|
| 74750-0030 | Single light pipe |
| 74750-0031 | Dual light pipe |

| Heat Sink | Heat Sink Clip |
|----------------------------|----------------|
| 74750-0300 | 74750-0305 |

I/O Products

0.80mm (.031") Pitch QSFP Cables

74757 Copper Patch Cables

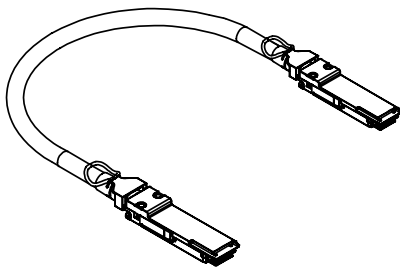

Features and Benefits

- Cables meet QSFP MSA standard
- Data rates scale up to 10 Gbps per lane providing higher bandwidth than SFP
- Unique pull to release latch enables belly-to-belly cable use and higher port density

Reference Information

Packaging: Bag
 Mates With: 75586
 Use With: 74750
 Designed In: Millimeters

Electrical

Voltage: 3.3V
 Current: 30mA max.

Mechanical

Contact Insertion Force: 40N (9.0 lbf) max.
 Contact Retention to Housing: 90N (20.2 lbf) min.
 Durability: 250 mating cycles

Physical

Back shell Housing: Zinc die cast
 Plating: Nickel
 PCB contact: Gold

| Order No. | Length | Cable Gauge | Lead-free |
|----------------------------|----------------|-------------|-----------|
| 74757-1101 | 1.0m (3.28') | 30 | Yes |
| 74757-1301 | 3.0m (6.56') | | |
| 74757-1501 | 5.0m (16.40') | | |
| 74757-9001 | 10.0m (32.80') | | |
| 74757-9006 | 15.0m (49.20') | | |
| 74757-2101 | 1.0m (3.28') | | |
| 74757-3301 | 3.0m (6.56') | | |
| 74757-3501 | 5.0m (16.40') | | |
| 74757-9003 | 10.0m (32.80') | | |
| 74757-9007 | 15.0m (49.20') | | |

| Order No. | Length | Cable Gauge | Lead-free |
|----------------------------|----------------|-------------|-----------|
| 74757-3101 | 1.0m (3.28') | 26 | Yes |
| 74757-3301 | 3.0m (6.56') | | |
| 74757-3501 | 5.0m (16.40') | | |
| 74757-9004 | 10.0m (32.80') | | |
| 74757-9008 | 15.0m (49.20') | | |
| 74757-4101 | 1.0m (3.28') | | |
| 74757-4301 | 3.0m (6.56') | | |
| 74757-4501 | 5.0m (16.40') | | |
| 74757-9005 | 10.0m (32.80') | | |
| 74757-9009 | 15.0m (49.20') | | |

1.27mm (.050") Pitch PCIe 1X Receptacle

74150
SMT, Right Angle

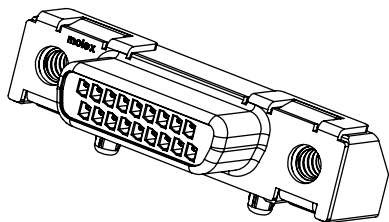

Features and Benefits

- Complies with the PCI SIG specifications
- Supports 2.5 Gbps data transfer rate for Gen I and 5.0 Gbps data transfer rates for Gen II
- Inline SMT leads on 0.64mm (.025") pitch provide direct PCB routing
- High cycle LFH™ shrouded contact system provides 2 points of contact for optimal signal integrity
- Optional jack posts available in 4-40 or M3 threads for use with jackscrews for positive mating retention

Reference Information

Packaging: Embossed tape
Mates With: 74155 plug
Use With: 74962 jackposts
Designed In: Millimeters

Electrical

Voltage: 40V
Current: 1.5A
Contact Resistance: 20 milliohms max.
Dielectric Withstanding Voltage: 500V
Insulation Resistance: 100 Megohms min.
Differential Impedance:
2.5 Gbps: 100 ± 10 ohms at 150psec risetime
5.0 Gbps: 100 ± 18 ohms at 75psec risetime

Mechanical

Contact Insertion Force: 0.60N (0.13 lbf) per circuit
Insertion Force to PCB: 44.50N (10.00 lbf) total
Mating Force: 11.17N (2.51 lbf) per circuit
Unmating Force: 6.7N (1.5 lbf) per circuit
Normal Force: 75 grams
Durability: 1,500 cycles

Physical

Housing: Black LCP, UL 94V-0
Contact: Copper Alloy
Plating: 15µ" min. Select Gold
Shield: Deep-drawn Steel

| Circuits | Order No. | Threaded inserts* | Lead-free |
|----------|----------------------------|-------------------|-----------|
| 18 | 74150-0001 | 4-40 | Yes |

* Also available with M3 threaded inserts

1.27mm (.050") Pitch PCIe 1X Plug

74155
Wire Terminated Cable Plug

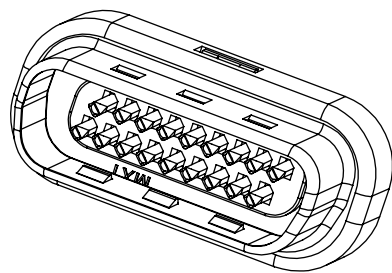

Features and Benefits

- Complies with the PCI SIG specifications
- Supports 2.5 Gbps data transfer rate for Gen I and 5.0 Gbps data transfer rates for Gen II
- First-mate/last-break pins B1 and A9 prevent damage to electrical circuitry when "hot plug" mating
- LFH™ contact design provides shallow mating angle, reducing insertion forces
- Terminates to 24 to 32 AWG high-performance wire through soldering or resistance welding
- Standard and custom cable assemblies available, 74576 series

Reference Information

Packaging: Tubes
Mates With: 74150 receptacle
Designed In: Millimeters

Electrical

Voltage: 40V
Current: 1.5A
Contact Resistance: 20 milliohms max.
Dielectric Withstanding Voltage: 500V
Insulation Resistance: 200 Megohms min.
Differential Impedance:
2.5Gbps: 100 ± 10 ohms at 150psec risetime
5.0Gbps: 100 ± 18 ohms at 75psec risetime

Mechanical

Contact Insertion Force: 0.60N (0.13 lbf) per circuit
Insertion Force to PCB: 44.50N (10.00 lbf) total
Mating Force: 11.17N (2.51 lbf) per circuit
Unmating Force: 6.7N (1.5 lbf) per circuit
Normal Force: 75 g
Durability: 1,500 cycles

Physical

Housing: Black LCP, UL 94V-0
Contact: Copper Alloy
Plating: 15µ" min. Select Gold
Shield: Deep-drawn Steel

| Circuits | Order No. | Description | Lead-free |
|----------|----------------------------|---------------------------------------|-----------|
| 18 | 74155-0001 | Plug assembled with pre-trimmed tails | Yes |

Also available in Nickel-plated tails for terminations requiring welding

0.80mm (.031") Pitch
iPass™
Wire-to-Board
Host Connector
75586
Right Angle, SMT

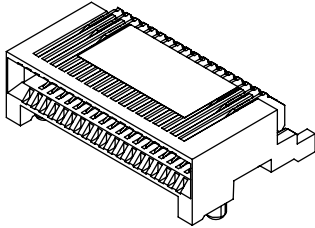

Features and Benefits

- Designed for placement beneath guide frame for external applications
- High-temperature thermoplastic for lead-free processing
- Alignment posts provide stability for placement on the PCB
- Standoffs allow for easy PCB cleaning after soldering
- SMT design allows for ease of routing and provides the option for placement on both sides of the PCB

Reference Information

Product Specification: PS-75586-001
 Packaging: Tape and reel
 Mates With: 74546 and 74547
 Use With: 74540 and 74548
 Designed In: Millimeters

Electrical

Voltage: 30V
 Current: 0.5A max.
 Contact Resistance: 30 milliohms max.
 Dielectric Withstanding Voltage: 500V AC
 Insulation Resistance: 1000 Megohms min.

Mechanical

Contact Retention to Housing: 4.5N min.
 Mating Force: 2.36N per circuit
 Unmating Force: 0.15N per circuit
 Normal Force: 0.49N min.
 Durability: 250 cycles

Physical

Housing: Black glass-filled high-temperature thermoplastic, UL 94V-0
 Contact: Copper Alloy
 Plating: Contact Area—Gold
 Solder Tail Area—Tin
 Underplating—Nickel

| Circuits | Order No. | Plating | Lead-free |
|----------|----------------------------|------------------|-----------|
| 26 | 75586-0004 | 0.38 (15µm) Gold | Yes |
| | 75586-0009 | 0.76 (30µm) Gold | |
| 36 | 75586-0003 | 0.38 (15µm) Gold | |
| | 75586-0008 | 0.76 (30µm) Gold | |
| 38 | 75586-0010 | 0.38 (15µm) Gold | |
| | 75586-0011 | 0.76 (30µm) Gold | |
| 50 | 75586-0001 | 0.38 (15µm) Gold | |
| | 75586-0006 | 0.76 (30µm) Gold | |
| 68 | 75586-0002 | 0.38 (15µm) Gold | |
| | 75586-0007 | 0.76 (30µm) Gold | |

www.molex.com/product/iPass.html

(1.18") Pitch Cage-to-Cage
(0.75") Pitch Port-to-Port
iPass™
Wire-to-Board
Multi-port Guide Frame
74548
SAS/SATA

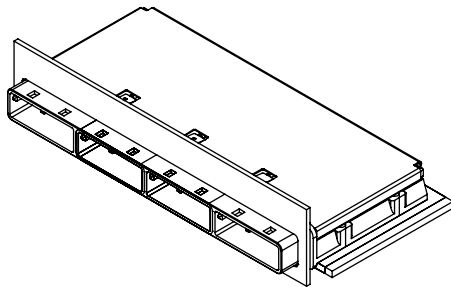

Features and Benefits

- Multiple guide rail configurations provide board design flexibility
- Diecast guide rail provides robust chassis-to-chassis interface
- Guide frame gaskets provide improved EMI performance
- Screw attachment for the guide rail to PCB provides a durable I/O connection during the cable management process

Reference Information

Packaging: Tray
 Mates With: 74547
 Use With: 75586
 Designed In: Millimeters

Mechanical

Retention to PCB: Threaded Screw—M2

Physical

Housing: Zinc diecast
 Housing Plating: Nickel over Tin

| Order No. | Port Size | Key | Lead-free |
|----------------------------|---|-----|-----------|
| 74548-0117 | 1 by 4 EMI Guide Housing Assembly 1 Degree—SAS | 2 | Yes |
| 74548-0118 | 1 by 2 EMI Guide Housing Assembly 1 Degree—SAS | | |
| 74548-0119 | 1 by 1 EMI Guide Housing Assembly 1 Degree—SAS | | |
| 74548-0120 | 1 by 4 EMI Guide Housing Assembly 1 Degree—SAS | 6 | |
| 74548-0121 | 1 by 2 EMI Guide Housing Assembly 1 Degree—SAS | | |
| 74548-0122 | 1 by 1 EMI Guide Housing Assembly 1 Degree—SAS | | |
| 74548-0123 | 1 by 4 EMI Guide Housing Assembly 1 Degree—SRiO | 3 | |
| 74548-0124 | 1 by 2 EMI Guide Housing Assembly 1 Degree—SRiO | | |
| 74548-0125 | 1 by EMI Guide Housing Assembly 1 Degree—SRiO | | |

| Order No. | Port Size | Key | Lead-free |
|----------------------------|---|-----|-----------|
| 74548-0217 | 1 by 4 EMI Guide Housing Assembly 0 Degree—SAS | 2 | Yes |
| 74548-0218 | 1 by 2 EMI Guide Housing Assembly 0 Degree—SAS | | |
| 74548-0219 | 1 by 1 EMI Guide Housing Assembly 0 Degree—SAS | | |
| 74548-0220 | 1 by 4 EMI Guide Housing Assembly 0 Degree—SAS | 6 | |
| 74548-0221 | 1 by 2 EMI Guide Housing Assembly 0 Degree—SAS | | |
| 74548-0222 | 1 by 1 EMI Guide Housing Assembly 0 Degree—SAS | | |
| 74548-0223 | 1 by 4 EMI Guide Housing Assembly 0 Degree—SRiO | 3 | |
| 74548-0224 | 1 by 2 EMI Guide Housing Assembly 0 Degree—SRiO | | |
| 74548-0225 | 1 by EMI Guide Housing Assembly 0 Degree—SRiO | | |

0.80mm (.031") Pitch iPass™ Wire-to-Board Guide Frame

74540
X4 and X8 PCIe

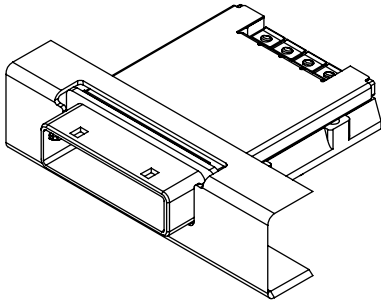

Features and Benefits

- Diecast guide frame provides robust cable-to-chassis interface
- Guide frame gaskets provide improved EMI performance
- Multiple guide frame configurations provide board design flexibility
- Alignment posts provide stability for placement on the PCB
- Screw attachment for the guide frame provides sturdy, durable connection to the PCB

Reference Information

Packaging: Tray
Mates With: 74546
Use With: 75586
Designed In: Millimeters

Mechanical

Retention to PCB: Threaded Screw—M2

Physical

Housing: Zinc diecast
Plating: Nickel over Tin

| Circuits | Lane | Order No. | Application | Lead-free |
|----------|------|----------------------------|----------------------|-----------|
| 38 | 4X | 74540-0401 | PCIe add-in cards | Yes |
| | | 74540-0501 | Standard host boards | |
| 68 | 8X | 74540-0101 | PCIe add-in cards | |
| | | 74540-0201 | Standard host boards | |

www.molex.com/hpc/

0.80mm (.031") Pitch iPass™ Wire-to-Board Integrated Connector Assembly

75581
Compliant Pin, Right Angle
X16 PCIe

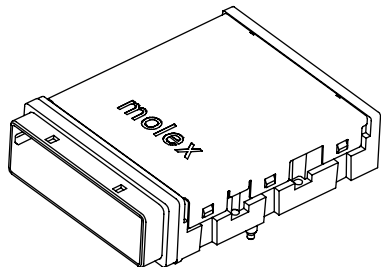

Features and Benefits

- Integrated press-fit connector assembly with cage provides one-step placement to PCB
- Four integral screw mount hold downs applied from the bottom of the PCB provide optimal retention of the die cast assembly to the PCB without taking up additional real estate
- Low profile height (13.13mm) fits standard and low profile PCIe add-in cards
- Two robust guide pins located on each side help to align assembly to PCB
- Front elastomeric gasket provides improved EMI protection to face plate
- Eight ground pad alleys are located at the rear of the die cast assembly to provide ease of routing off top layers of PCB

Reference Information

Product Specification: PS-75586-001
Packaging: Tray
Mates With: 74546
Designed In: Millimeters

Electrical

Voltage: 30V
Current: 0.5A
Dielectric Withstanding Voltage: 500V AC
Insulation Resistance: 1000 Megohms min.

Mechanical

Mating Force: 2.36N per circuit
Unmating Force: 0.15N per circuit
Normal Force: 0.49N min.
Durability: 250 Cycles

Physical

Housing: Black glass-filled high-temperature thermoplastic, UL 94V-0
Contact: Copper Alloy
Plating: Contact Area—Gold
Solder Tail Area—Tin
Underplating—Nickel
PCB Thickness: .070" min.

| Circuits | Order No. | Plating | Lead-free |
|----------|----------------------------|------------------|-----------------------------|
| 136 | 75581-0001 | 0.38 (15µ") Gold | RoHS compliant by exemption |
| | 75581-0002 | 0.76 (30µ") Gold | |

0.80mm (.031") Pitch iPass™ Wire-to-Board Host Connector/Shell Kit 75784 Vertical

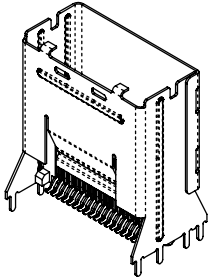

Features and Benefits

- SMT host connector is packaged with vertical shell for one-step placement to the PCB
- Pre-positioning device aligns the connector to the shell and acts as disposable cap for robotic placement to PCB
- Four keying options prevent mismatching
- Retention-fit, through hole and SMT shell configurations provide processing flexibility
- Multiple solder tail lengths accommodate PCB thickness from 1.57 to 3.18mm
- Tape-and-reel packaging for robotic placement to PCB

Reference Information

Product Specification: PS-75783-001
Packaging: Tape and reel
Mates With: 79536, 79576 and 74562
Designed In: Millimeters

Electrical

Voltage: 30V
Current: 0.5A max.
Contact Resistance: 30 milliohms max.
Dielectric Withstanding Voltage: 500V AC
Insulation Resistance: 1000 Megohms min.

Mechanical

Contact Retention to Housing: 4.5N min.
Insertion Force to PCB: 25N max.
Mating Force: 2.36N per circuit
Unmating Force: 0.15N per circuit
Normal Force: 0.49N min.
Durability: 25 cycles

Physical

Housing: Black glass-filled high-temperature thermoplastic, UL 94V-0
Contact: Copper Alloy
Plating: Contact Area—0.38µm (15µ") and 0.76µm (30µ") Gold
Solder Tail Area—Tin
Underplating—Nickel

| Circuits | Order No. | Shell PCB | PC Tail Length | Shell Key | Lead-free |
|----------|----------------------------|---------------|----------------|-----------|-----------|
| 26 | 75784-0009 | Retention-fit | 1.96mm | Dual | Yes |
| | 75784-0031 | Through Hole | | | |
| | 75784-0012 | SMT | | | |
| 36 | 75784-0109 | Retention-fit | 1.96mm | | |
| | 75784-0131 | Through Hole | 1.96mm | | |
| | 75784-0139 | Through Hole | 2.79mm | | |
| | 75784-0147 | Through Hole | 3.18mm | | |
| | 75784-0155 | Through Hole | 3.56mm | | |
| | 75784-0112 | SMT | 1.96mm | | |
| 50 | 75784-0209 | Retention-fit | 1.96mm | | |
| | 75784-0231 | Through Hole | | | |
| | 75784-0212 | SMT | | | |
| 68 | 75784-0309 | Retention-fit | 1.96mm | | |
| | 75784-0331 | Through Hole | | | |
| | 75784-0312 | SMT | | | |

Note: See Sales Drawing for 0.76µm (30µ") ordering information

0.80mm (.031") Pitch
iPass™
Wire-to-Board
Host Connector/Shell Kit
75783
Right Angle

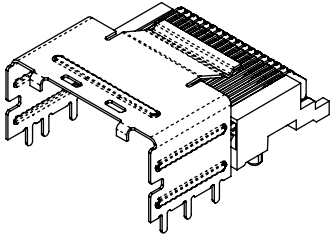

Features and Benefits

- SMT host connector is packaged with right angle shell for one-step placement to the PCB
- Pre-positioning device aligns the connector to the shell and acts as disposable cap for robotic placement to PCB
- Four keying options prevent mismatching
- Retention-fit, through hole and SMT shell configurations provide processing flexibility
- Multiple solder tail lengths accommodate PCB thickness from 1.57 to 3.18mm
- Tape-and-reel packaging for robotic placement to PCB

Reference Information

Product Specification: PS-75783-001
 Packaging: Tape and reel
 Mates With: 79536, 79576 and 74562
 Designed In: Millimeters

Electrical

Voltage: 30V
 Current: 0.5A max.
 Contact Resistance: 30 milliohms max.
 Dielectric Withstanding Voltage: 500V AC
 Insulation Resistance: 1000 Megohms min.

Mechanical

Contact Retention to Housing: 4.5N min. per circuit
 Insertion Force to PCB: 25N max.
 Mating Force: 2.36N per circuit
 Unmating Force: 0.15N per circuit
 Normal Force: 0.49N min.
 Durability: 25 cycles

Physical

Housing: Black glass-filled high-temperature thermoplastic, UL 94V-0
 Contact: Copper Alloy
 Plating: Contact Area—0.38µm (15µ") and 0.76µm (30µ") Gold
 Solder Tail Area—Tin
 Underplating—Nickel

| Circuits | Order No. | Shell PCB | PC Tail Length | Shell Key | Lead-free |
|----------|----------------------------|---------------|----------------|-----------|-----------|
| 26 | 75783-0009 | Retention-fit | 1.96mm | Dual | Yes |
| | 75783-0031 | Through Hole | | | |
| | 75783-0012 | SMT | | | |
| 36 | 75783-0109 | Retention-fit | 1.96mm | | |
| | 75783-0131 | Through Hole | 1.96mm | | |
| | 75783-0139 | Through Hole | 2.79mm | | |
| | 75783-0147 | Through Hole | 3.18mm | | |
| | 75783-0155 | Through Hole | 3.56mm | | |
| | 75783-0112 | SMT | 1.96mm | | |
| 50 | 75783-0209 | Retention-fit | 1.96mm | | |
| | 75783-0231 | Through Hole | | | |
| | 75783-0212 | SMT | | | |
| 68 | 75783-0309 | Retention-fit | 1.96mm | | |
| | 75783-0331 | Through Hole | | | |
| | 75783-0312 | SMT | | | |

Note: See Sales Drawing for 0.76µm (30µ") ordering information

0.80mm (.031") Pitch iPass™ External Cable Mini Multi-Lane Cable Assembly

74547

Double-ended, 26-Circuit

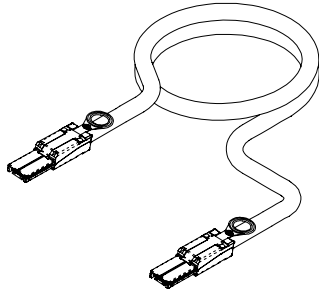

Features and Benefits

- Reduced plug width provides the ability to support a higher number of ports in the same space as the SFF-8470 solution
- High performance paddle card design provides improved signal integrity through impedance matching and reduced crosstalk
- Cable snout gasket provides improved EMI performance
- Loopback module available for SAS, CX4

Reference Information

Mates With: 75586
Use With: 74548
Designed In: Millimeters

Electrical

Voltage: 30V AC
Current: 1.0A

Mechanical

Latch-to-Cage Retention Force: 88.96N (20 lbf)
Mating Force: 68.95N (15.5 lbf)
Unmating Force: 62.28N (14 lbf)
Durability: 250 cycles

Physical

Housing: Zinc diecast
Housing Plating: Nickel over Zinc
PCB Contact: Gold over Nickel

I/O Products

N

| Length | Order No. | Protocol | Key | Lead-free |
|----------------|----------------------------|---------------|---------|-----------|
| 1.0m (3.28') | 74547-0101 | SFF-8088 SAS | 2,4 | Yes |
| 3.0m (9.84') | 74547-0103 | | | |
| 6.0m (19.68') | 74547-0106 | | | |
| 1.0m (3.28') | 74547-0201 | | 4,6 | |
| 3.0m (9.84') | 74547-0203 | | | |
| 6.0m (19.68') | 74547-0206 | | | |
| 1.0m (3.28') | 74547-0301 | | 2,4,6 | |
| 3.0m (9.84') | 74547-0303 | | | |
| 6.0m (19.68') | 74547-0306 | | | |
| 3.0m (9.84') | 74547-0399 | | 2,4,4,6 | |
| 1.0m (3.28') | 74547-0120 | | | |
| 3.0m (9.84') | 74547-0122 | | | |
| 6.0m (19.68') | 74547-0125 | SFF-8088 SATA | 1,4 | |
| 1.0m (3.28') | 74547-0001 | | | |
| 3.0m (9.84') | 74547-0003 | | | |
| 6.0m (19.68') | 74547-0006 | | 7 | |
| 1.0m (3.28') | 74547-0401 | | | |
| 3.0m (9.84') | 74547-0403 | | | |
| 6.0m (19.68') | 74547-0406 | SRI0 | 3 | |
| 1.0m (3.28') | 74547-5001 | | | |
| 3.0m (9.84') | 74547-5003 | | | |
| 6.0m (19.68') | 74547-5006 | CX4 | 2,7 | |
| 1.0m (3.28') | 74547-7001 | | | |
| 5.0m (16.4') | 74547-7005 | | | |
| 10.0m (32.80') | 74547-7010 | | | |
| | 74547-7015 | | | |
| 15.0m (49.20') | 74547-0699 | Loopback | | |

Note: Additional lengths available on sales drawing shown on website.

0.80mm (.031") Pitch iPass™ PCIe Cable

74546

4X, 8X, 16X PCIe

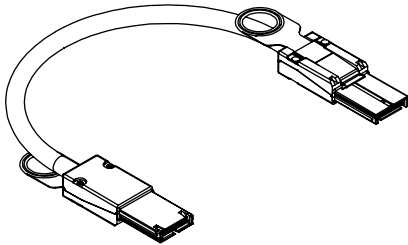

Features and Benefits

- Reduced plug width allows customers to populate (4)x4 ports and (2)x8 ports on a standard PCIe card
- Lower external plug profile reduces cable bend radius versus standard 4x LaneLink™ cable assemblies
- Flexible latch pull provides an intuitive latch and unlatch mechanism

Reference Information

Packaging: Box
Mates With: 75586
Use With: 74540
Designed In: Millimeters

Electrical

Voltage: 30V AC
Current: 1.0A
Contact Resistance: 30 milliohms max.
Dielectric Withstanding Voltage: 240V
Insulation Resistance: 40 Megohms min.

Mechanical

Latch to Cage Retention Force: 20 lbf min.
Durability: 250 cycles

Physical

Housing: Zinc diecast
PCB Contact: Gold over Nickel
Housing Plating: Nickel over Zinc

| Length | Order No. | Lane/Circuits | Lead-free |
|---------------|----------------------------|---------------|-----------|
| 1.0m (3.28') | 74546-0401 | 4X/38 | Yes |
| 7.0m (22.96') | 74546-0407 | | |
| 1.0m (3.28') | 74546-0801 | 8X/68 | |
| 7.0m (22.96') | 74546-0807 | | |
| 1.0m (3.28') | 74546-1601 | 16X/136 | |
| 7.0m (22.96') | 74546-1607 | | |

Note: Additional lengths available on sales drawing shown on website.

0.80mm (.031")/ 0.50mm (.020") Pitch iPass™ to LaneLink™ External Mini Multi-Lane to External Multi-Lane Cable Assembly

74547

**26 Circuit External iPass to
4X LaneLink Cable**

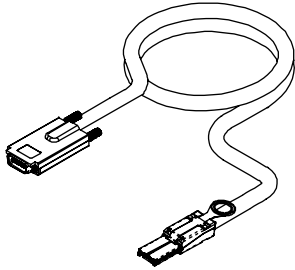

Features and Benefits

- Sturdy jackscrew hardware provides user with guaranteed mating to the PCB connector
- Diecast backshell provides EMI protection
- High-performance paddle card design provides improved signal integrity through impedance matching and reduced crosstalk
- Cable snout gasket provides improved EMI performance

Reference Information

iPass

Mates With: 75586

Use With: 74548

Designed In: Millimeters

LaneLink

Mates With: 91659

Use With: 74735 and 74739

Designed In: Millimeters

Electrical

Voltage: 30V

Current: 1.0A

Mechanical

iPass

Latch-to-Cage Retention Force: 88.96N (20 lbf)

Mating Force: 68.95N (15.5 lbf)

Unmating Force: 62.28N (14 lbf)

Durability: 250 cycles

LaneLink

Mating Force: 55.5N (12.48 lbf)

Unmating Force: 49.0N (11.02 lbf)

Durability: 250 cycles

Physical

iPass

Housing: Zinc diecast

Housing Plating: Nickel over Zinc

PCB Contact: Gold over Nickel

LaneLink

Housing: Zinc diecast

Contact: Gold flashw

Housing Plating: Nickel

I/O Products

N

| Protocol | Order No. | Length | Key | Lead-free |
|----------------------------|----------------------------|----------------|---------|-----------|
| SAS | 74547-2021 | 1.0m (3.28') | 2, 4 | Yes |
| | 74547-2023 | 3.0m (9.84') | | |
| | 74547-2026 | 6.0m (19.68') | | |
| | 74547-2041 | 1.0m (3.28') | 4, 6 | |
| | 74547-2043 | 3.0m (9.84') | | |
| | 74547-2046 | 6.0m (19.68') | | |
| | 74547-2051 | 1.0m (3.28') | 2, 4, 6 | |
| | 74547-2053 | 3.0m (9.84') | | |
| 74547-2056 | 6.0m (19.68') | | | |
| SATA | 74547-2001 | 1.0m (3.28') | 1, 4 | |
| | 74547-2003 | 3.0m (9.84') | | |
| | 74547-2006 | 6.0m (19.68') | | |
| | 74547-2061 | 1.0m (3.28') | 7 | |
| | 74547-2063 | 3.0m (9.84') | | |
| | 74547-2066 | 6.0m (19.68') | | |
| CX4 | 74547-7010 | 1.0m (3.28') | 2.7 | |
| | 74547-7050 | 5.0m (16.4') | | |
| | 74547-7100 | 10.0m (32.80') | | |
| | 74547-7150 | 15.0m (49.20') | | |

Note: Additional lengths on sales drawing shown on website.

0.80mm (.031")/ 0.80mm (.031") Pitch iPass™ External Mini Multi-Lane to Internal Mini Multi-Lane Cable Assembly

74547
External 26-Circuit SAS to
Internal 36-Circuit SAS
(SFF-8088 to SFF-8087)

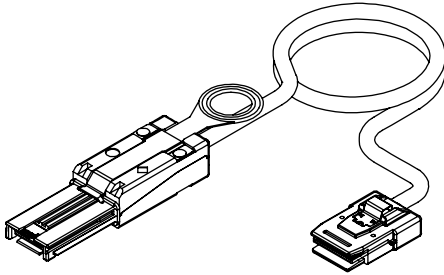

| Length | Order No. | Lead-free |
|--------------|----------------------------|-----------|
| 0.5m (1.64') | 74547-3301 | Yes |
| 1.0m (3.28') | 74547-3302 | |

Features and Benefits

- Interface adapter cable provides ability to mate between various SAS and SATA interconnects
- iPass cable plug offers streamlined narrow latch pull design allowing for more dense cable management
- Reduced plug width provides the ability to support a higher number of ports in the same space as the SFF-8470 solution

Reference Information

Packaging: Bag
Mates With: External—75586
Internal—75783, 75784
Use With: External—74548
Designed In: Millimeters

Electrical

Voltage: 30V AC
Current: 0.5A

Mechanical

Latch-to-Cage Retention Force: 88.96N (20 lbf)

External SFF-8088

Mating Force: 68.95N (15.5 lbf)
Unmating Force: 62.28N (14.0 lbf)
Durability: 250 cycles

Internal SFF-8087

Latch-to-Cage Retention Force: 4.45N (1.00 lbf) per circuit
Mating Force: 1.25N (.28 lbf) per circuit
Unmating Force: 25N (0.6 lbf) per circuit
Durability: 25 cycles

Physical

External SFF-8088

Housing: Zinc Die Cast
Housing Plating: Nickel
PCB Contact: Gold
Operating Temperature: -20 to +85°C

Internal SFF-8087

Housing: Black glass-filled high-temperature thermoplastic, UL 94V-0
Contact: Copper Alloy

0.80mm (.031")/ 1.27mm (.050") Pitch iPass™ External Mini Multi-Lane to Internal 1X SATA Cable Assembly

74557
26-Circuit SAS External to
(4) 1X SATA
(SF-8088 to 1X SATA)

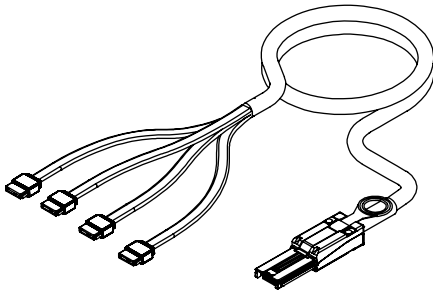

| Length | Order No. | Pinout | Pinout Orientation | Lead-free |
|--------------|----------------------------|-------------------|----------------------|-----------|
| 0.5m (1.64') | 74557-0001 | Straight | Transmit P0 to P1-P4 | Yes |
| 1.0m (3.28') | 74557-0002 | | | |
| 0.5m (1.64') | 74557-0003 | Straight—pinout 2 | | |
| 1.0m (3.28') | 74557-0004 | | | |

Features and Benefits

- Interface adapter cable provides ability to mate between various SAS and SATA interconnects
- iPass cable plug offers streamlined narrow latch pull design allowing for more dense cable management
- Reduced plug width provides the ability to support a higher number of ports in the same space as the SFF-8470 solution

Reference Information

Packaging: Bag
Mates With: Internal—47080, 67490, 67800
External—75586
Use With: External—74548
Designed In: Millimeters

Electrical

Voltage: 30V AC
Current: 0.5A

Mechanical

External SFF-8088

Latch-to-Cage Retention Force: 88.96N (20 lbf)
Mating Force: 68.95N (15.5 lbf)
Unmating Force: 62.28N (14 lbf)
Durability: 250 cycles

Internal SATA

Mating Force: 45N per circuit (10.12 lbf)
Unmating Force: 10N per circuit (2.25 lbf)
Durability: 500 cycles

Physical

External SFF-8088

Housing: Zinc diecast
Housing Plating: Nickel
PCB Contact: Gold

Internal SATA

Housing: Black glass-filled thermoplastic, UL 94V-0
Contact: 30µ" min. Gold over Nickel

| Length | Order No. | Pinout | Pinout Orientation | Lead-free |
|--------------|----------------------------|--------------------|----------------------|-----------|
| 0.5m (1.64') | 74557-1001 | Crossover | Transmit P0 to P1-P4 | Yes |
| 1.0m (3.28') | 74557-1002 | | | |
| 0.5m (1.64') | 74557-1003 | Crossover—pinout 2 | | |
| 1.0m (3.28') | 74557-1004 | | | |

0.80mm (.031") Pitch iPass™ Internal Mini Multi-Lane Cable Assembly

79576
Double-ended
36-Circuit SAS (SFF-8087)

74573
Right Angle (SFF-8087)

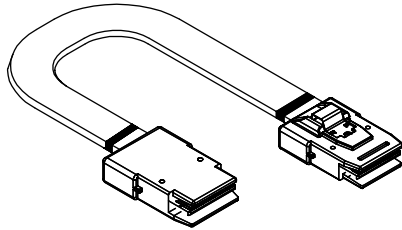

Features and Benefits

- All internal iPass assemblies are capable of supporting SAS/SATA generation I and II bandwidths which allows the customer to use the same connector/cable solution for next generation systems
- Positive and passive latching ensures that the plug remains mated to receptacle
- Reduced mechanical size offers up to 4 times the port density of the current x4 solution

Reference Information

Packaging: Bag
Mates With: 75783 and 75784
Designed In: Millimeters

Electrical

Voltage: 30V AC
Current: 1.0A
Contact Resistance: 30 milliohms max.
Dielectric Withstanding Voltage: 240V
Insulation Resistance: 40 Megohms min.

Mechanical

Latch-to-Cage Retention Force: 44.48N (10.00 lbf)
Mating Force: 55.60N (12.5 lbf)
Unmating Force: 48.93N (11.00 lbf)
Durability: 25 cycles

Physical

Housing: Black glass-filled thermoplastic, UL 94V-0
Contact: 30µ" min. Gold over Nickel

| Length | Order No. | Sidebands | Application | Lead-free |
|--------------|----------------------------|-----------|--------------------------|-----------|
| 0.5m (1.64') | 79576-2102 | Yes | Controller to Backplane | Yes |
| 1.0m (3.28') | 79576-2104 | | | |
| 0.5m (1.64') | 79576-2112 | | Controller to Controller | |
| 1.0m (3.28') | 79576-2114 | | | |
| 0.5m (1.64') | 74573-2102 | | Controller to Backplane | |
| | 74573-2112 | | | |

Note: Additional lengths shown on website.

www.molex.com/hpc/

I/O Products

N

0.80mm (.031") Pitch iPass™ Internal Cable Assembly

74596
Double Ended
50 Circuit

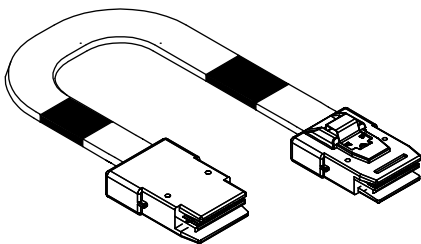

Features and Benefits

- All internal iPass assemblies are capable of supporting SAS/SATA generation I and II bandwidths, which allows the customer to use the same connector/cable solution for next generation systems
- Positive and passive latching ensures that the plug remains mated to the receptacle
- Interface adapter cables provide the ability to mate between the various standard SAS and SATA interconnects
- One 50 circuit cable utilizes less board space than two 26 circuit cables

Reference Information

Packaging: Bag
Mates With: 75783 and 75784
Designed In: Millimeters

Electrical

Voltage: 30V AC
Current: 1.0A

Mechanical

Latch to Cage Retention: 30N (6.74 lbf) min.
Mating Force: 82.5N (18.55 lbf)
Unmating Force: 32.5N (7.31 lbf)
Durability: 50 cycles

Physical

Housing: Black glass-filled thermoplastic, UL 94V-0
Contact: 30µ" Gold over Nickel

| Order No. | Length | Application | Sidebands | Lead-free |
|----------------------------|----------------|-------------------------|-----------|-----------|
| 74596-5000 | 0.152m (0.50') | Controller to Backplane | No | Yes |
| 74596-5001 | 0.300m (0.98') | | | |
| 74596-5002 | 0.500m (3.28') | | | |
| 74596-5003 | 0.600m (1.97') | | | |
| 74596-5004 | 1.00m (3.28') | | | |

0.80mm (.031") Pitch iPass™ Internal Cable Assembly

74586
Double Ended
68 Circuit

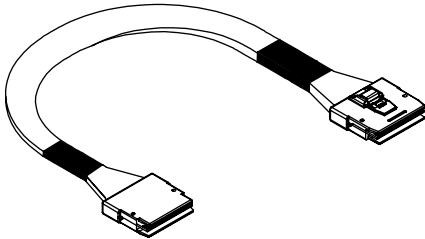

Features and Benefits

- All internal iPass assemblies are capable of supporting SAS/SATA generation I and II bandwidths, which allows the customer to use the same connector/cable solution for next generation systems
- Positive and passive latching ensures that the plug remains mated to the receptacle
- Interface adapter cables provide the ability to mate between the various standard SAS and SATA interconnects
- One 68 circuit cable utilizes less board space than two 36 circuit cables

Reference Information

Packaging: Bag
Mates With: 75783 and 75784
Designed In: Millimeters

Electrical

Voltage: 30V AC
Current: 1.0A

Mechanical

Latch to Cage Retention: 30N (6.74 lbf) min.
Mating Force: 105N (23.61 lbf)
Unmating Force: 37 (7.31 lbf)
Durability: 50 cycles

Physical

Housing: Black glass-filled thermoplastic, UL 94V-0
Contact: 30µm Gold over Nickel

| Order No. | Length | Application | Sidebands | Lead-free |
|----------------------------|----------------|--------------------------|-----------|-----------|
| 74586-2100 | 0.152m (0.50') | Controller to Backplane | Yes | Yes |
| 74586-2101 | 0.300m (0.98') | | | |
| 74586-2102 | 0.500m (3.28') | | | |
| 74586-2103 | 0.600m (1.97') | | | |
| 74586-2104 | 1.00m (3.28') | | | |
| 74586-2110 | 0.152m (0.50') | Controller to Controller | Yes | |
| 74586-2111 | 0.300m (0.98') | | | |
| 74586-2112 | 0.500m (3.28') | | | |
| 74586-2113 | 0.600m (1.97') | | | |
| 74586-2114 | 1.00m (3.28') | | | |
| 74586-2120 | 0.152m (0.50') | N/A | No | |
| 74586-2121 | 0.300m (0.98') | | | |
| 74586-2122 | 0.500m (3.28') | | | |
| 74586-2123 | 0.600m (1.97') | | | |
| 74586-2124 | 1.00m (3.28') | | | |

www.molex.com/product/iPass.html

0.80mm (.031") Pitch iPass™ Internal Mini SAS Cable Assembly

79575
Double-ended
26-Circuit SAS (SFF-8087)

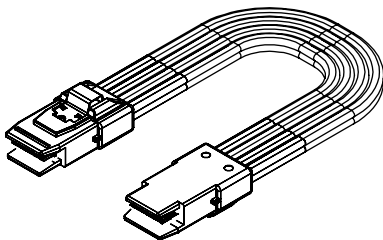

Features and Benefits

- All internal iPass assemblies are capable of supporting SAS/SATA generation I and II bandwidths, which allows the customer to use the same connector/cable solution for next generation systems
- Positive and passive latching ensures that the plug remains mated to the receptacle
- Reduced mechanical size offers up to 4 times the port density of the current x4 solution

Reference Information

Packaging: Bag
Mates With: 75783 and 75784
Designed In: Millimeters

Electrical

Voltage: 30V AC
Current: 1.0A
Contact Resistance: 30 milliohms max.
Dielectric Withstanding Voltage: 240V
Insulation Resistance: 40 Megohms min.

Mechanical

Latch-to-Cage Retention Force: 44.48N (10.00 lbf)
Mating Force: 55.60N (12.5 lbf)
Unmating Force: 48.93N (11.00 lbf)
Durability: 25 cycles

Physical

Housing: Black glass-filled thermoplastic, UL 94V-0
Contact: 30µm min. Gold over Nickel

| Circuits | Length | Order No. | Lead-free |
|----------|----------------|----------------------------|-----------|
| 26 | 0.152m (0.49') | 79575-2000 | Yes |
| | 0.3m (0.98') | 79575-2001 | |
| | 0.5m (1.64') | 79575-2002 | |
| | 0.6m (1.96') | 79575-2003 | |
| | 1.0m (3.28') | 79575-2004 | |

Note: Additional lengths on sales drawing shown on website.

0.80mm (.031") Pitch iPass™ Internal Mini SAS Cable Assembly

74573
90 Degree, Right Angle
36 Circuit

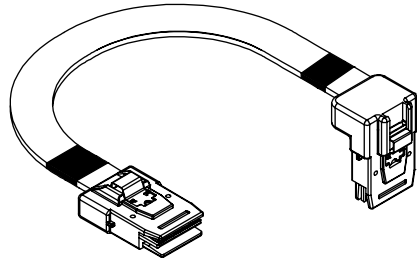

Features and Benefits

- All internal iPass assemblies are capable of supporting SAS/SATA generation I and II bandwidths, which allows the customer to use the same connector/cable solution for next generation systems
- Positive and passive latching ensures that the plug remains mated to the receptacle
- Interface adapter cables provide the ability to mate between the various standard SAS and SATA interconnects

Reference Information

Packaging: Bag
Mates With: 75783 and 75784
Designed In: Millimeters

Electrical

Voltage: 30V AC
Current: 1.0A

Mechanical

Latch to Cage Retention Force: 30N (6.74 lbf)
Mating Force: 55.60N (12.5 lbf)
Unmating Force: 48.93N (11.00 lbf)
Durability: 50 cycles

Physical

Housing: Black glass-filled thermoplastic, UL 94V-0
Contact: 30µm min. Gold over Nickel

| Order No. | Length | Application | Sidebands | Lead-free |
|----------------------------|----------------|--------------------------|-----------|-----------|
| 74573-2100 | 0.152m (0.50') | Controller to Backplane | Yes | Yes |
| 74573-2101 | 0.300m (0.98') | | | |
| 74573-2102 | 0.500m (1.64') | | | |
| 74573-2103 | 0.600m (1.97') | | | |
| 74573-2104 | 1.00m (3.28') | | | |
| 74573-2110 | 0.152m (0.50') | Controller to Controller | Yes | |
| 74573-2111 | 0.300m (0.98') | | | |
| 74573-2112 | 0.500m (1.64') | | | |
| 74573-2113 | 0.600m (1.97') | | | |
| 74573-2114 | 1.00m (3.28') | None | No | |
| 74573-2120 | 0.152m (0.50') | | | |
| 74573-2121 | 0.300m (0.98') | | | |
| 74573-2122 | 0.500m (1.64') | | | |
| 74573-2123 | 0.600m (1.97') | | | |
| 74573-2124 | 1.00m (3.28') | | | |

I/O Products

N

0.80mm (.031") Pitch iPass™ Internal Cable Assembly

111018
90 Degree, Right Angle
50 Circuit

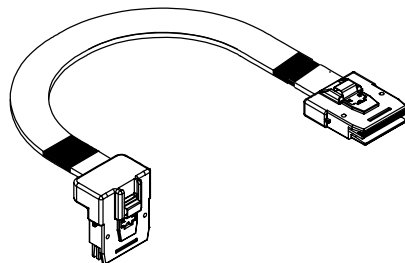

Features and Benefits

- All internal iPass assemblies are capable of supporting SAS/SATA generation I and II bandwidths, which allows the customer to use the same connector/cable solution for next generation systems
- Positive and passive latching ensures that the plug remains mated to the receptacle
- Interface adapter cables provide the ability to mate between the various standard SAS and SATA interconnects

Reference Information

Packaging: Bag
Mates With: 75783 and 75784
Designed In: Millimeters

Electrical

Voltage: 30V AC
Current: 1.0A

Mechanical

Latch to Cage Retention Force: 30N (6.75 lbf) min.
Mating Force: 82.5N (18.55 lbf)
Unmating Force: 32.5N (7.31 lbf)
Durability: 50 cycles

Physical

Housing: Black glass-filled thermoplastic, UL 94V-0
Contact: 30µm Gold over Nickel

| Order No. | Length | Application | Sidebands | Lead-free |
|-----------------------------|----------------|-------------------------|-----------|-----------|
| 111018-0000 | 0.152m (0.50') | Controller to Backplane | No | Yes |
| 111018-0001 | 0.300m (0.98') | | | |
| 111018-0002 | 0.500m (3.28') | | | |
| 111018-0003 | 0.600m (1.97') | | | |
| 111018-0004 | 1.00m (3.28') | | | |

**0.80mm (.031")/
1.27mm (.050") Pitch
iPass™
Internal 26 Circuit
Mini SAS to Internal
Multi-Lane
Cable Assembly**

79575
SFF-8484

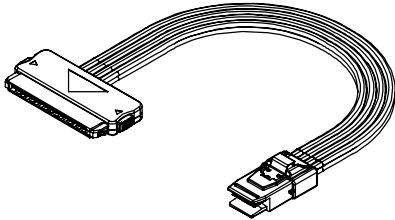

Features and Benefits

- All internal iPass assemblies are capable of supporting SAS/SATA generation I and II bandwidths which allows use of the same connector/cable solution for next generation systems
- Positive and passive latching ensures that the plug remains mated to receptacle
- Interface adapter cables provide the ability to mate between the various standard SAS and SATA interconnects

Reference Information

Packaging: Bag
Mates With: Mini SAS—75783, 75784
SFF-8484—87968, 87862, 87959, 87861, 87969
Designed In: Millimeters

Electrical

Voltage: 30V AC
Current: 1.0A

Mechanical

26 Circuit
Latch to Cage Retention Force: 44.48N (10.00 lbf)
Mating Force: 55.60N (12.5 lbf)
Unmating Force: 48.93N (11.00 lbf)
Durability: 25 cycles

8484
Mating Force Internal: 45N (10.12 lbf) max.
Unmating Force Internal: 20N (4.5 lbf) min. with latch engaged
Durability: 50 cycles

Physical

26 Circuit
Housing: Black glass-filled thermoplastic, UL 94V-0
Contact: 30µ" min. Gold over Nickel

8484
Housing: Black glass-filled thermoplastic, UL 94V-0
Contact: 30µ" min. Gold over Nickel and Copper Alloy

| Order No. | Orientation | Length | Lead-Free |
|----------------------------|-------------|--------------|-----------|
| 79575-5002 | Vertical | 0.5m (1.64') | Yes |
| 79575-5004 | | 1.0m (3.28') | |

**0.80mm (.031")/
1.27mm (.050") Pitch
iPass™
Internal Mini SAS to
Serial ATA
Cable Assembly**

79575
26-Circuit to (4) 1X SATA

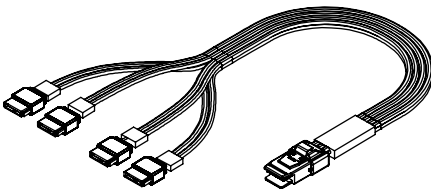

Features and Benefits

- All internal iPass assemblies are capable of supporting SAS/SATA generation I and II bandwidths, which allows the customer to use the same connector/cable solution for next generation systems
- Positive and passive latching ensures that the plug remains mated to the receptacle
- Interface adapter cables provide the ability to mate between the various standard SAS and SATA interconnects

Reference Information

Packaging: Bag and box
Mates With: SATA—47080, 67490, 67800
SAS—75783 and 75784
Designed In: Millimeters

Electrical

Voltage: 30V AC
Current: 1.0A

Mechanical

26 Circuit
Latch-to-Cage Retention Force: 44.48N (10.00 lbf)
Mating Force: 55.60N (12.5 lbf)
Unmating Force: 48.93N (11.00 lbf)
Durability: 25 cycles

SATA
Mating Force Internal: 45N per circuit (10.12 lbf)
Unmating Force Internal: 10N per circuit (2.25 lbf)
Durability: 500 cycles

Physical

26 Circuit
Housing: Black glass-filled thermoplastic, UL 94V-0
Contact: 30µ" min. Gold over Nickel

SATA
Housing: Black glass-filled thermoplastic, UL 94V-0
Contact: 30µ" min. Gold over Nickel

| Length | Order No. | Application | Lead-free |
|--------------|----------------------------|-------------------------|-----------|
| 0.5m (1.64') | 79575-3002 | Backplane to Controller | Yes |
| 1.0m (3.28') | 79575-3004 | | |

Note: Additional lengths on sales drawing shown on website.

0.80mm (.031")/ 1.27mm (.050") Pitch iPass™ Internal Mini Multi-Lane to Internal Multi-Lane Cable Assembly

79576
(SFF-8088 to SFF-8484)

74562
(SFF-8088 to Right Angle
SFF-8484)

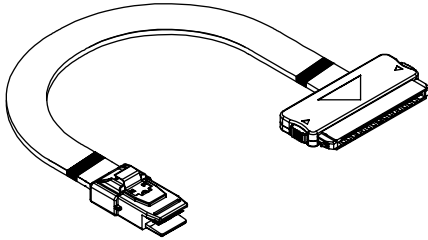

Features and Benefits

- All internal iPass assemblies are capable of supporting SAS/SATA generation I and II bandwidths which allows the customer to use the same connector/cable solution for next generation systems
- Positive and passive latching ensures that the plug remains mated to receptacle
- Interface adapter cables provide the ability to mate between the various standard SAS and SATA interconnects

Reference Information

Packaging: Bag and box
Mates With: SFF-8088—75783, 75784
SFF-8484—87861, 87862, 87959, 87968
and 87969
Designed In: Millimeters

Electrical

Voltage: 30V AC
Current: 1.0A

Mechanical

SFF-8088

Latch-to-Cage Retention Force: 44.48N (10.00 lbf)
Mating Force: 55.60N (12.5 lbf)
Unmating Force: 48.93N (11.00 lbf)
Durability: 25 cycles

SFF-8484

Mating Force Internal: 45N (10.12 lbf) max.
Unmating Force Internal: 20N (4.5 lbf) min. with latch
engaged
Durability: 50 cycles

Physical

SFF-8088

Housing: Black glass-filled thermoplastic, UL 94V-0
Contact: 30μm min. Gold over Nickel

SFF-8484

Housing: Black glass-filled thermoplastic, UL 94V-0
Contact: 30μm min. Gold over Nickel and Copper Alloy

| Length | Order No. | Orientation | Application—Sidebands | Lead-free |
|--------------|----------------------------|-------------|-----------------------|-----------|
| 0.5m (1.64') | 79576-5002 | Vertical | iPass on Backplane | Yes |
| 1.0m (3.28') | 79576-5004 | | iPass on Controller | |
| 0.5m (1.64') | 79576-9002 | | No Side Bands | |
| 1.0m (3.28') | 79576-9004 | | | |
| 0.5m (1.64') | 79576-5022 | | | |
| 1.0m (3.28') | 79576-5024 | | | |
| 0.5m (1.64') | 74562-5002 | Right Angle | iPass on Backplane | |
| 1.0m (3.28') | 74562-5004 | | | |
| 0.5m (1.64') | 74562-5102 | | No Side Bands | |
| 1.0m (3.28') | 74562-5104 | | | |

Note: Additional lengths available on sales drawing shown on website.

**0.80mm (.031")/
1.27mm (.050") Pitch**

iPass™

**Internal Mini Multi-Lane to
Serial ATA
Cable Assembly**

79576/79536

**36-Circuit to (4) 1X SATA
(SFF-8087 to 1X SATA)**

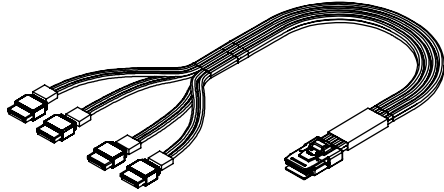

Features and Benefits

- All internal iPass assemblies are capable of supporting SAS/SATA generation I and II bandwidths, which allows the customer to use the same connector/cable solution for next generation systems
- Positive and passive latching ensures that the plug remains mated to the receptacle
- Interface adapter cables provide the ability to mate between the various standard SAS and SATA interconnects

Reference Information

Packaging: Bag and box
Mates With: 1X SATA—47080, 67490, 67800
36-Circuit SATA—75783 and 75784
Designed In: Millimeters

Electrical

Voltage: 30V AC
Current: 1.0A

Mechanical

SFF-8087
Latch-to-Cage Retention Force: 44.48N (10.00 lbf)
Mating Force: 55.60N (12.5 lbf)
Unmating Force: 48.93N (11.00 lbf)
Durability: 25 cycles

SATA
Mating Force Internal: 45N per circuit (10.12 lbf)
Unmating Force Internal: 10N per circuit (2.25 lbf)
Durability: 500 cycles

Physical

SFF-8087
Housing: Black glass-filled thermoplastic, UL 94V-0
Contact: 30µ" min. Gold over Nickel

SATA
Housing: Black glass-filled thermoplastic, UL 94V-0
Contact: 30µ" min. Gold over Nickel

| Length | Order No. | Application | Sidebands | Lead-free |
|--------------|----------------------------|---------------------|-----------|-----------|
| 0.5m (1.64') | 79576-3002 | iPass on Backplane | No | Yes |
| 1.0m (3.28') | 79576-3007 | | | |
| 0.5m (1.64') | 79576-3003 | iPass on Controller | No | |
| 1.0m (3.28') | 79576-3005 | | | |
| 0.5m (1.64') | 79536-3013 | iPass on Backplane | Yes | |
| 1.0m (3.28') | 79536-3015 | | | |
| 0.5m (1.64') | 79536-3003 | iPass on Controller | Yes | |
| 1.0m (3.28') | 79536-3005 | | | |
| 0.5m (1.64') | 79536-3023 | | | |
| 1.0m (3.28') | 79536-3025 | | | |

Note: Additional lengths available on sales drawing shown on website.

0.50mm (.020")/ 1.27mm (.050") Pitch LaneLink™ to iPass™ Cable Assembly External Multi-Lane 4X to Mini SAS 4i, 4X Jackscrew Cable Assembly

74527

**4X SAS LaneLink to
SAS iPass Cable
(SFF-8470 to SFF-8484)**

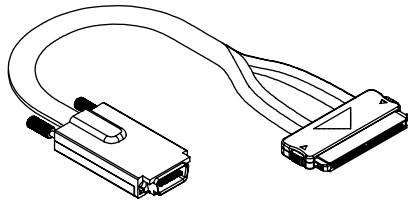

| Length | Order No. | Description | Pinout Orientation | Lead-free |
|--------------|----------------------------|-----------------------------|----------------------|-----------|
| 0.5m (1.64') | 74527-4001 | Straight (P1 to P1) pinout | Transmit to Transmit | Yes |
| 1.0m (3.28') | 74527-4002 | | | |
| 0.5m (1.64') | 74527-4101 | Crossover (P1 to P4) pinout | Transmit to Receive | |
| 1.0m (3.28') | 74527-4102 | | | |

Features and Benefits

- Interface adapter cable provides the ability to mate between various SAS and SATA interconnects with existing systems that use SFF-8470
- Jackscrew options complies with SFF-8470, which meets SFF committee standard specifications
- Internal plug offers positive and passive latching to ensure plug remains latched to receptacle

Reference Information

Packaging: Bag and box
Mates With: External—91659
Internal—87861, 87862, 87959, 87968,
87969
Designed In: Millimeters

Electrical

Voltage: 0.5A
Current: 30V AC

Mechanical

External SFF-8470
Mating Force External: 55.5N (12.48 lbf)
Unmating Force Internal: 49.0N (11.02 lbf)
Durability: 250 cycles

Internal SFF-8484

Latch to Cage Retention Force: 44.48N (10.0 lbf)
Mating Force Internal: 55.60N (12.50 lbf)
Unmating Force Internal: 48.93N (11.0 lbf)
Durability: 25 cycles

Physical

External SFF-8470
Housing: Zinc diecast
Contact: Gold flash
Housing Plating: Nickel

Internal SFF-8484

Housing: Black glass-filled thermoplastic, UL 94V-0
Contact: 30µ" min. Gold over Nickel

0.50mm (.020")/ 0.80mm (.031") Pitch LaneLink™ to iPass™ External Multi-Lane to Internal Mini-Multi Lane 4X Jackscrew Cable Assembly

74527

**4X SAS LaneLink to
36-Circuit SAS iPass Cable
(SFF-8470 to SFF-8087)**

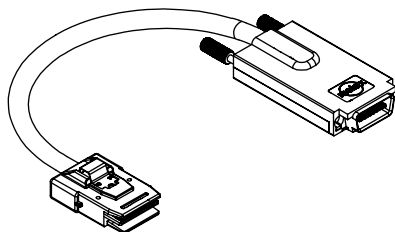

| Length | Order No. | Lead-free |
|--------------|----------------------------|-----------|
| 0.5m (1.64') | 74527-6021 | Yes |
| 1.0m (3.28') | 74527-6022 | |

Features and Benefits

- Interface adapter cable provides the ability to mate between various SAS and SATA interconnects with existing systems that use SFF-8470
- Jackscrew options complies with SFF-8470, which meets SFF committee standard specifications
- Internal plug offers positive and passive latching to ensure plug remains latched to receptacle

Reference Information

Packaging: Bag
Mates With: External—91659
Internal—75783, 75784
Use With: 74735 and 74739
Designed In: Millimeters

Electrical

Voltage: 0.5A
Current: 30V AC

Mechanical

External SFF-8470
Mating Force: 55.5N (12.48 lbf)
Unmating Force: 49.0N (11.0 lbf)
Durability: 250 cycles

Internal SFF-8087

Mating Force: 55.60N (12.50 lbf)
Unmating Force: 48.93N (11.0 lbf)
Latch to Cage Retention Force: 44.48N (10 lbf)
Durability: 25 cycles

Physical

External SFF-8470
Housing: Zinc diecast
Contact: Gold flash
Housing Plating: Nickel

Internal SFF-8087

Housing: Black glass-filled thermoplastic, UL 94V-0
Contact: 30µ" min. Gold over Nickel

High Definition Multimedia Interface* (HDMI) Shielded I/O Cable Assembly/Adapter

88768

**HDMI to HDMI
HDMI to DVI**

88764

HDMI Adapters

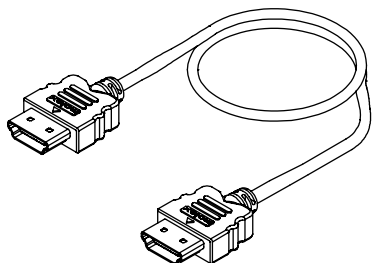

| Cable Assembly Lengths (mm) | Wire Gauge (AWG) | Order No. | Description | Lead-free |
|-----------------------------|------------------|----------------------------|--------------|-----------|
| 1000 | 28 | 88768-3500 | HDMI to DVI | Yes |
| 2000 | | 88768-3510 | | |
| 3000 | | 88768-3520 | | |
| 5000 | | 88768-3530 | | |
| 1000 | 30 | 88768-3600 | HDMI to DVI | |
| 2000 | | 88768-3610 | | |
| 3000 | | 88768-3620 | | |
| 1000 | 28 | 88768-9800 | HDMI to HDMI | |
| 2000 | | 88768-9810 | | |
| 3000 | | 88768-9820 | | |
| 5000 | | 88768-9830 | | |
| 1000 | 30 | 88768-9900 | HDMI to HDMI | |
| 2000 | | 88768-9910 | | |
| 3000 | | 88768-9920 | | |

*High Definition Multimedia Interface and HDMI are trademarks of HDMI Licensing, LLC.

Features and Benefits

- Compact, user-friendly design meets consumer equipment needs
- 5 Gbps bandwidth supports uncompressed audio/video in a single cable
- HDMI-DVI cables DVI backward compatible
- Fully shielded ESD protection

Reference Information

Product Specification: PS-88768-001 and PS-88768-002
Packaging: Bag or custom-specified
Mates With: HDMI and DVI header
Designed In: Millimeters

Electrical

Voltage: 40V
Current: 0.5A
Contact Resistance: 30 milliohms max.
Dielectric Withstanding Voltage: 300 AC (rms)
Insulation Resistance: 100 Megohms min.

Mechanical

Insertion Force: 44.1N max.
Withdraw Force: 39.2N max.
9.2N min.
Durability: 10000 cycle

Physical

Contact: Copper Alloy
Plating: Contact Area—0.75µm (30µ") min. Gold
Underplating: Nickel
Wire Gauge: 28, 30 AWG

| Order No. | Adapters Description | Lead-free |
|----------------------------|------------------------------|-----------|
| 88764-2000 | HDMI Male to DVI Female | Yes |
| 88767-0600 | HDMI Female to DVI Male | |
| 88764-5900 | HDMI Female to P&D (M1) Male | |

www.molex.com/product/io/hdmi.html

I/O Products

N

0.50mm (.012") Pitch DisplayPort* Cable Adapter

74766

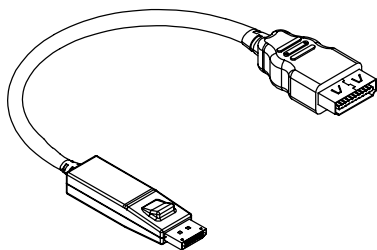

| Order No. | Legacy Side | Lead-free |
|----------------------------|-----------------|-----------|
| 74766-0005 | HDMI | Yes |
| 74766-0006 | Single link DVI | |
| 74766-8005 | HDMI | |
| 74766-8006 | Single link DVI | |

*DisplayPort is a trademark of Video Electronics Standards Association (VESA)

†HDMI is a trademark of HDMI Licensing, LLC

Features and Benefits

- Meets VESA DisplayPort 1.1a, HDMI† 1.0, DVI-D 1.0 and VGA industry standards
- Meets IEC-61000-4-2 ESD
- Sleek mechanical design allows multiple cable adapters to be used close together
- Five inches of cable provide exceptional flexibility to use the adapter in many different applications

Reference Information

Packaging: Bag
Mates With: 47623, 47272, 105020, 105019 and 105080
Designed In: Millimeters

Electrical

Voltage: 3.3V
Current: 300mA max.

Mechanical

Insertion Force: 44.1N (9.91 lbf) max.
Unmating Force with latches: 49N (11.02 lbf)
Durability: 100 cycles

Physical

Housing: Black Thermoplastic UL 94V-0
Contact Plating: Gold
Wire Gauge: 32 Awg

www.molex.com/product/displayport.html



MX10 N-33

2.00mm (.079") Pitch IEEE 1394-1995 Shielded I/O PCB Socket

53462

**Right Angle, Flat, SMT
With Kinked Metal Pegs**

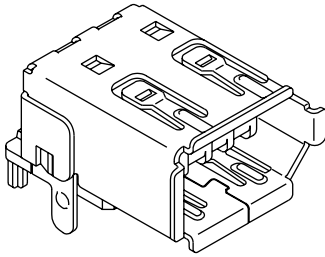

| Circuits | Order No. | Lead-free |
|----------|----------------------------|-----------|
| 6 | 53462-0629 | Yes |

Note: Molex's IEEE 1394 connector and cable products are licensed for use exclusively with the 1394 BUS technology. Use of this product contrary to this restriction will constitute a violation of certain license restrictions and may pose a serious safety hazard.

Features and Benefits

- Size 6 circuits
- Provides the interface for speeds up to 400 Mbps
- Full metal shielding for ESD protection
- High-temperature plastic housing for SMT processing
- Rugged Gold-plated leaf contacts withstand up to 1500 cycles
- Polarized shell design and friction lock grounding fingers ensure plug retention

Reference Information

Packaging: Tray
Mates With: 59233-700X, 88763-25XX and 88763-26XX
Designed In: Millimeters

Electrical

Voltage: 40V
Current: 1.5A
Contact Resistance: Terminal—30 milliohms max. (6 pin)
50 milliohms max. (4 pin)
Shell—50 milliohms max.
Dielectric Withstanding Voltage: 500V AC/1 min.
Insulation Resistance: 1 Gigaohm min. (4 pin)
100 Megohms min. (6 pin)

Physical

Housing: Black glass-filled 4/6 nylon, UL 94V-0 or equivalent
Shell: Phosphor Bronze, Tin over Nickel plating
Contact: Brass
Plating: Contact area—Gold over Nickel
Solder Tail Area—Tin over Nickel

2.00mm (.079") Pitch IEEE 1394-1995 Shielded I/O PCB Socket

53984

**Right Angle
Flat**

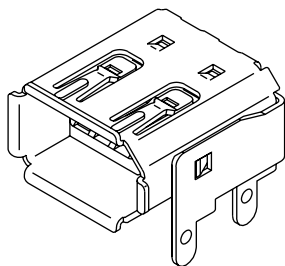

| Circuits | Order No. | Lead-free |
|----------|----------------------------|-----------|
| 6 | 53984-0671 | Yes |

Note: Molex's IEEE 1394 connector and cable products are licensed for use exclusively with the 1394 BUS technology. Use of this product contrary to this restriction will constitute a violation of certain license restrictions and may pose a serious safety hazard.

Features and Benefits

- Size 6 circuits
- Provides the interface for speeds up to 400 Mbps
- Four metal PCB retention pegs for additional hold-down
- High-temperature plastic housing for SMT processing
- Rugged Gold-plated leaf contacts withstand up to 1500 cycles
- Polarized shell design and friction lock grounding fingers ensure plug retention

Reference Information

Packaging: Tray
Mates With: 59233-70XX, 88763-25XX and 88763-26XX
Designed In: Millimeters

Electrical

Voltage: 40V
Current: 1.5A
Contact Resistance: Terminal—30 milliohms max. (6 pin)
50 milliohms max. (4 pin)
Shell—50 milliohms max.
Dielectric Withstanding Voltage: 500V AC/1 min.
Insulation Resistance: 1 Gigaohm (4 pin)
100 Megohms (6 pin)

Physical

Housing: Black glass-filled 4/6 nylon, UL 94V-0 or equivalent
Shell: Phosphor Bronze, Tin over Nickel plating
Contact: Brass
Plating: Contact area—Gold over Nickel
Solder Tail Area—Tin over Nickel

2.00mm (.079") Pitch IEEE 1394-1995 Shielded I/O PCB Socket

53460

**Right Angle, Upright
With Kinked Metal Pegs**

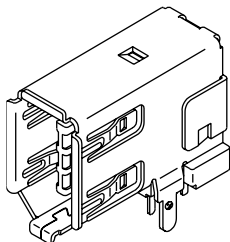

| Circuits | Order No. | Lead-free |
|----------|----------------------------|-----------|
| 6 | 53460-0629 | Yes |

Note: Molex's IEEE 1394 connector and cable products are licensed for use exclusively with the 1394 BUS technology. Use of this product contrary to this restriction will constitute a violation of certain license restrictions and may pose a serious safety hazard.

Features and Benefits

- Size 6 circuits
- Provides the interface for speeds up to 400 Mbps
- Full metal shielding for ESD protection
- High-temperature plastic housing for SMT processing
- Rugged Gold-plated leaf contacts withstand up to 1500 cycles
- Polarized shell design and friction lock grounding fingers ensure plug retention

Reference Information

Packaging: Tray
Mates With: 59233-700X, 88763-25XX and 88763-26XX
Designed In: Millimeters

Electrical

Voltage: 40V
Current: 1.5A
Contact Resistance: Terminal—30 milliohms max. (6 pin)
50 milliohms max. (4 pin)
Shell—50 milliohms max.
Dielectric Withstanding Voltage: 500V AC/1 min.
Insulation Resistance: 1 Gigaohm (4 pin)
100 Megohms (6 pin)

Physical

Housing: Black glass-filled 4/6 nylon, UL 94V-0 or equivalent
Shell: Phosphor Bronze, Tin over Nickel plating
Contact: Brass
Plating: Contact area—Gold over Nickel
Solder Tail Area—Tin over Nickel

www.molex.com/product/1394.html

Universal Serial Bus (USB) Shielded I/O Type 'A' Receptacle

89485

**Single Upright
Right Angle**

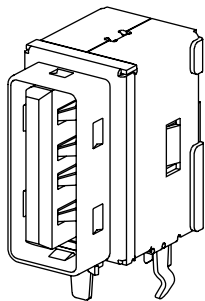

| Circuits | Order No. | Plating | Lead-free |
|----------|----------------------------|------------|-----------|
| 4 | 89485-8000 | Gold Flash | Yes |
| | 89485-8001 | 30µ" Gold | |

Features and Benefits

- Small footprint saves PCB real estate
- Metal shell with back-shield offers all-round EMI/RFI shielding
 - Staked-housing provides excellent solder tail alignment facilitating PCB mounting
 - Dimples at inlet serve as locking feature and plug retention
 - Panel grounding pins for ESD protection
 - Kinked boardlocks provide strong board retention

Reference Information

Product Specification: PS-89485
Packaging: Tray
Mates With: USB 'A' Plug
Designed In: Millimeters

Electrical

Voltage: 30V
Current: 1.0A
Contact Resistance: 30 milliohms max.
Dielectric Withstanding Voltage: 750V AC
Insulation Resistance: 1000 Megohms min.

Mechanical

Mating Force: 35N max.
Withdrawal Force: 10N min.
Durability: 1500 cycles

Physical

Housing: Black high-temperature, glass fiber-filled nylon, UL 94V-0
Contact: Phosphor Bronze
Metal Shell: Steel Alloy
Plating: Gold Flash or 30µ" Gold

Universal Serial Bus (USB) I/O Receptacle

48204

**Type A, Surface Mount
Right Angle, Shielded**

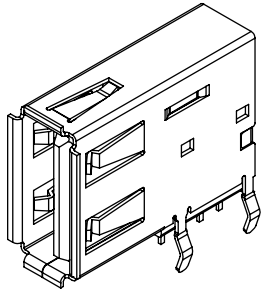

| Order No. | Lead-free |
|----------------------------|-----------|
| 48204-0001 | Yes |

Features and Benefits

- Small footprint saves PCB real estate
- Metal shell with back shield offers all-around EMI/RFI shielding
- Spring-beam shell contacts offer plug retention force
- Four beveled metal pins provide strong board retention

Reference Information

Product Specification: PS-48204-001
Packaging: Tray
Designed in: Millimeters

Electrical

Voltage: 30V
Current: 1.5A
Contact Resistance: 30 milliohms max.
Dielectric Withstanding Voltage: 500V AC
Insulation Resistance: 1000 Megohms min.

Mechanical

Mating Force: 35.00N
Unmating Force: 10.00N
Durability: 1500 cycles

Physical

Housing: Glass-filled high-temperature thermoplastic, UL 94V-0
Contact: Phosphor Bronze
Plating: Contact Area—30µ" Gold
Solder Tail Area—Tin
Underplating: Nickel

Universal Serial Bus (USB) Shielded I/O Type 'B' Receptacle

67068

**Single
Right Angle, Kinked Version**

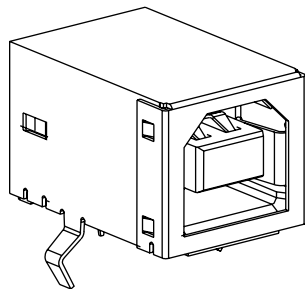

| Circuits | Order No. | Housing Color | Plating | Lead-free |
|----------|----------------------------|---------------|------------|-----------|
| 4 | 67068-8000 | Black | Gold Flash | Yes |
| | 67068-8001 | | 30µ" Gold | |
| | 67068-9000 | White | Gold Flash | |
| | 67068-9001 | | 30µ" Gold | |

Features and Benefits

- Metal shell with back-shield provides all round EMI/RFI shielding
- Staked-housing provides excellent solder tail alignment facilitating PCB mounting
- Multiple internal grounding fingers
- Stand-offs for anti-solder bridging
- Kinked boardlocks provide strong board retention

Reference Information

Product Specification: PS-67998-0000
UL File No.: E29179
CSA File No.: LR19980A
Packaging: Tray
Mates With: USB 'B' Plug
Designed In: Millimeters

Electrical

Voltage: 30V
Current: 1.0A
Contact Resistance: 30 milliohms max.
Dielectric Withstanding Voltage: 750V AC
Insulation Resistance: 1000 Megohms min.

Mechanical

Mating Force: 35N max.
Withdrawal Force: 10N min.
Durability: 1500 cycles min.

Physical

Housing: Black or white glass fiber-filled polyester, UL 94V-0
Contact: Phosphor Bronze
Metal Shell: Copper Alloy
Plating: Gold Flash or 30µ" Gold

Universal Serial Bus (USB) Shielded I/O Type 'B' Receptacle

67068

**Single Right Angle with
Straight Tabs**

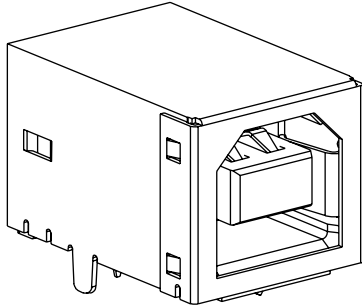

Features and Benefits

- Straight tabs suited for pick-and-place feeder
- Metal shell provides full EMI/RFI shielding
- Staked housing provides excellent solder-tail alignment facilitating PCB mounting
- Housing stand-offs for anti-solder bridging
- Housing available in black or white

Reference Information

Product Specification: PS-67998-0000
Packaging: Tray or tube
Mates With: USB 'B' Plug
Designed In: Millimeters

Electrical

Voltage: 30V
Current: 1.0A
Contact Resistance: 30 milliohms max.
Dielectric Withstanding Voltage: 750V AC
Insulation Resistance: 1000 Megohms min.

Mechanical

Mating Force: 35N max.
Unmating Force: 10N min.
Durability: 1500 cycles

Physical

Housing: Black or white glass fiber-filled polyester, UL 94V-0
Contact: Phosphor Bronze
Metal Shell: Copper Alloy
Plating: Gold Flash or 30µ" Gold

| Circuits | Order No. | | Packaging | Plating | Lead-free |
|----------|----------------------------|----------------------------|-----------|------------|-----------|
| | Black | White | | | |
| 4 | 67068-8010 | 67068-9010 | Tray | Gold Flash | Yes |
| | 67068-8011 | 67068-9011 | | 30µ" Gold | |
| | 67068-8110 | 67068-9110 | Tube | Gold Flash | |
| | 67068-8111 | 67068-9111 | | 30µ" Gold | |

Universal Serial Bus (USB) Shielded I/O Cable Assembly

88732 'A-to-B' Full-Rated

'A-to-B' High Rated

88728 'A-to-Pigtail' Full-Rated

88738 'A-to-Pigtail' Sub-Channel

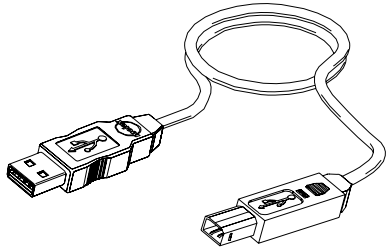

Features and Benefits

- Connector-to-connector polarization ensures proper mating
- Friction grip on over-molded body provides easy mating/unmating
- 5 standard cable lengths available for design flexibility
- Full shield provided EMI/RFI protection
- Other cable lengths and custom designs available

Reference Information

Product Specification: PS-87525
Packaging: Bag or custom-specified
Mates With: USB 'A' receptacle and USB 'B' receptacle
Designed In: Millimeters

Electrical

Voltage: 30V
Current: 1.0A
Contact Resistance: 30 milliohms max.
Dielectric Withstanding Voltage: 750V AC
Insulation Resistance: 1000 Megohms min.

Mechanical

Mating Force: 35N max.
Withdrawal Force: 10N min.
Durability: 1500 cycles min.

Physical

Contact: Copper Alloy
Plating: Contact Area—0.75 μ m (30 μ in.) min. Gold
Underplating: Nickel

| Order No. | Description | Cable Assembly Lengths (mm) | Lead-free |
|----------------------------|-----------------------------------|-----------------------------|-----------|
| 88738-8000 | USB Type A to Pigtail Sub-Channel | 810 White | Yes |
| 88738-8001 | | 810 Beige | |
| 88738-8100 | | 1310 White | |
| 88738-8101 | | 1310 Beige | |
| 88738-8200 | | 2080 White | |
| 88738-8201 | | 2080 Beige | |
| 88738-8300 | | 3330 White | |
| 88738-8301 | | 3330 Beige | |
| 88738-8400 | | 5000 White | |
| 88738-8401 | | 5000 Beige | |
| 88728-3200 | USB Type A to Pigtail Full-Rated | 810 White | |
| 88728-3202 | | 810 Black | |
| 88728-3300 | | 1310 White | |
| 88728-3302 | | 1310 Black | |
| 88728-3400 | | 2080 White | |
| 88728-3402 | | 2080 Black | |
| 88728-3500 | | 3330 White | |
| 88728-3502 | | 3330 Black | |
| 88728-3600 | | 5000 White | |
| 88728-3602 | | 5000 Black | |

| Order No. | Description | Cable Assembly Lengths (mm) | Lead-free |
|----------------------------|--|-----------------------------|-----------|
| 88732-8000 | USB Type A to Type B Full-Rated USB1.1 | 1000 White | Yes |
| 88732-8002 | | 1000 Black | |
| 88732-8100 | | 1800 White | |
| 88732-8102 | | 1800 Black | |
| 88732-9000 | | 820 White | |
| 88732-9002 | | 820 Black | |
| 88732-9100 | | 1320 White | |
| 88732-9102 | | 1320 Black | |
| 88732-9200 | | 2090 White | |
| 88732-9202 | | 2090 Black | |
| 88732-9300 | USB Type A to Type B Full-Rated USB2.0 | 3340 White | |
| 88732-9302 | | 3340 Black | |
| 88732-9400 | | 5000 White | |
| 88732-9402 | | 5000 Black | |
| 88732-9020 | | 820 White | |
| 88732-9120 | | 1320 Black | |
| 88732-9220 | | 2090 White | |

Universal Serial Bus (USB) Shielded I/O Type 'B' Receptacle

67171
Vertical

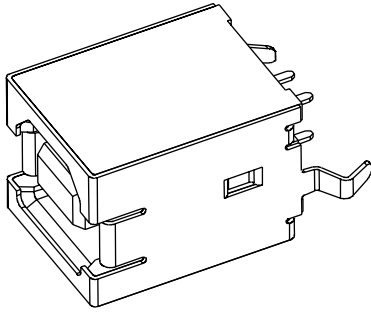

Features and Benefit

- Dual kinked boardlocks provide secure PCB retention
- Housing stand-off for anti-solder bridging
- Housing available in black or white

Reference Information

Product Specification: PS-67998-0000
Packaging: Tray
Mates With: USB 'B' Plug
Designed In: Millimeters

Electrical

Voltage: 30V
Current: 1.0A
Contact Resistance: 30 milliohms max.
Dielectric Withstanding Voltage: 750V AC
Insulation Resistance: 1000 Megohms min.

Mechanical

Mating Force: 35N max.
Unmating Force: 10N min.
Durability: 1500 cycles

Physical

Housing: Black or white glass fiber-filled polyester, UL 94V-0
Contact: Phosphor Bronze
Metal Shell: Copper Alloy
Plating: Gold Flash or 30µ" Gold

| Circuits | Order No. | | Plating | Lead-free |
|----------|----------------------------|----------------------------|------------|-----------|
| | Black | White | | |
| 4 | 67171-2000 | 67171-3000 | Gold Flash | Yes |
| | 67171-2001 | 67171-3001 | 30µ" Gold | |

www.molex.com/product/io/usb.html

mini-B™ USB On-the-Go (OTG) Shielded I/O Receptacle

54819

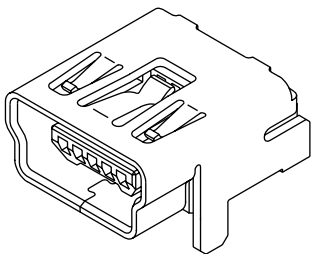

Features and Benefits

- Approximately 1/8 the size of standard USB-B connectors
- Fully compliant with current USB 2.0 specifications
- Compact and lightweight design meets various portable and mobile equipment needs
- Operates at speeds up to 480 Mbps
- Rugged durability up to 5,000 cycles

Reference Information

Product Specification: PS-54819-010
Packaging: Tray
Mates With: 59204-9405, 59205-3301
Designed In: Millimeters

Electrical

Voltage: 30V
Current: 1.0A
Contact Resistance: 50 milliohms max.
Dielectric Withstanding Voltage: 100V AC/1 min.
Insulation Resistance: 100 Megohms min.

Physical

Housing: Black glass-filled Polyphthal Amide, UL 94V-0
Contact: Copper Alloy
Plating: Contact Area—0.75µm (30µ") min. Gold
Solder Tail Area—Tin
Underplating—Nickel
Shield Case: Copper Alloy, Tin over Nickel plating

| Circuits | Order No. | Lead-free |
|----------|----------------------------|-----------|
| 5 | 54819-0519 | Yes |

mini-B™ USB On-the-Go (OTG) Shielded I/O Receptacle

54819
With Cover Tape
SMT

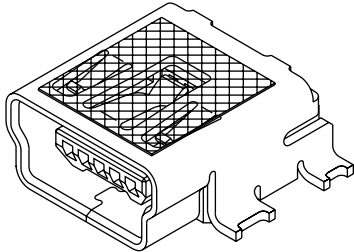

| Circuits | Order No. | Carrier Tape Width | Lead-free |
|----------|----------------------------|--------------------|-----------|
| 5 | 54819-0572 | 24.00 (.945) | Yes |

Features and Benefits

- Approximately 1/8 the size of standard USB-B connectors
- Fully compliant with current USB 2.0 specifications
- Compact and lightweight design meets various portable and mobile equipment needs
- Operates at speeds up to 480 Mbps
- Rugged durability up to 5,000 cycles

Reference Information

Product Specification: PS-54819-010
Packaging: Embossed tape
Mates With: 59204-9405, 59205-3301
Designed In: Millimeters

Electrical

Voltage: 30V
Current: 1.0A
Contact Resistance: 50 milliohms max.
Dielectric Withstanding Voltage: 100V AC/1 min.
Insulation Resistance: 100 Megohms min.

Physical

Housing: Black glass-filled Polyphthal Amide, UL 94V-0
Contact: Copper Alloy
Plating: Contact Area—0.75µm (30µ") min. Gold
Solder Tail Area—Tin
Underplating—Nickel
Shield Case: Copper Alloy, Tin over Nickel plating
Cover Tape: Polyimide

Universal Serial Bus (USB) On-The-Go (OTG) Shielded I/O Cable Assembly

88732
Standard USB A to Mini B
88753
Mini A to Mini B

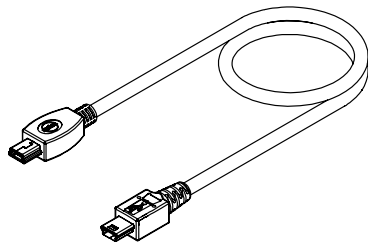

Features and Benefits

- Approximately 1/8 the size of standard USB-B connectors
- Connector-to-connector polarization ensures proper mating
- Full shield provides EMI/RFI protection
- Meets USB 2.0 specifications
- Compact and lightweight design meets various portable and mobile equipment needs
- Rugged durability up to 5,000 cycles
- Other cable lengths and custom designs available

Reference Information

Product Specification: PS-87525
Packaging: Bag or custom-specified
Mates With: USB A, Mini AB and Mini B receptacle
Designed In: Millimeters

Electrical

Voltage: 30V
Current: 1.0A
Contact Resistance: 50 milliohms max.
Dielectric Withstanding Voltage: 100V AC/min.
Insulation Resistance: 100 Megohms min.

Mechanical

Mating Force: 35N max.
Unmating Force: 10N min.
Durability: USB A—1500 cycles
Mini A and Mini B—5000 cycles

Physical

Contact: Copper Alloy
Plating: Contact Area—0.75µm (30µ") min. Gold
Underplating: Nickel
Wire Gauge: 28 AWG

| Cable Assembly Lengths (mm) | Order No. | Description | Lead-free |
|-----------------------------|----------------------------|--------------------------|-----------|
| 800 White | 88732-8510 | USB A to Mini B, USB 1.1 | Yes |
| 800 Black | 88732-8512 | | |
| 1000 White | 88732-8610 | | |
| 1000 Black | 88732-8612 | | |
| 1500 White | 88732-8710 | | |
| 1500 Black | 88732-8712 | | |
| 1800 White | 88732-8810 | | |
| 1800 Black | 88732-8812 | | |
| 2000 White | 88732-8910 | | |
| 2000 Black | 88732-8912 | | |
| 800 White | 88732-8500 | USB A to Mini B, USB 2.0 | Yes |
| 800 Black | 88732-8502 | | |
| 1000 White | 88732-8600 | | |
| 1000 Black | 88732-8602 | | |
| 1500 White | 88732-8700 | | |
| 1500 Black | 88732-8702 | | |
| 1800 White | 88732-8800 | | |
| 1800 Black | 88732-8802 | | |
| 2000 White | 88732-8900 | | |
| 2000 Black | 88732-8902 | | |

| Cable Assembly Lengths (mm) | Order No. | Description | Lead-free | | |
|-----------------------------|----------------------------|-------------------------------|-----------|-------------------------------|-----|
| 800 White | 88753-8110 | USB Mini A to Mini B, USB 1.1 | Yes | | |
| 1000 White | 88753-8210 | | | | |
| 1200 White | 88753-8310 | | | | |
| 1500 White | 88753-8410 | | | | |
| 1800 White | 88753-8510 | | | | |
| 2000 White | 88753-8610 | | | | |
| 800 White | 88753-8100 | | | USB Mini A to Mini B, USB 2.0 | Yes |
| 800 Black | 88753-8102 | | | | |
| 1000 White | 88753-8200 | | | | |
| 1000 Black | 88753-8202 | | | | |
| 1200 White | 88753-8300 | | | | |
| 1200 Black | 88753-8302 | | | | |
| 1500 White | 88753-8400 | | | | |
| 1500 Black | 88753-8402 | | | | |
| 1800 White | 88753-8500 | | | | |
| 1800 Black | 88753-8502 | | | | |
| 2000 White | 88753-8600 | | | | |
| 2000 Black | 88753-8602 | | | | |

InfiniBand* I/O Interconnect Solutions

The InfiniBand architecture is a new I/O technology created by key computer manufacturers to address the need for greater scalability, reliability, availability and performance in and around servers. This channel-based, switched fabric technology connects servers point-to-point with remote storage and networking devices and other servers.

The channel-based architecture allows the I/O ports to operate independently from the system memory, rather than through a shared bus configuration. Connections are made through host-channel adapters (HCAs) and target-channel adapters (TCAs), which can be on PCI cards, PCI express cards or InfiniBand carriers.

The InfiniBand specification is designed to support bandwidths of 2.5 Gbps in each single-directional link (5.0 Gbps bi-directionally). Scaling in bandwidth and frequency is done in links of 1-bit, 4-bit and 12-bit bi-directional connections (1X, 4X and 12X). The specification supports both copper and fiber implementations.

The InfiniBand specification provides a reference design for new form factor carriers designed to plug directly to a backplane in rack-style applications. The I/O panel on the carrier accommodates both copper and optical connections in range of high-density options.

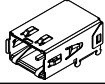
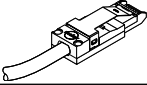
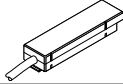
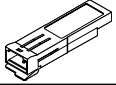
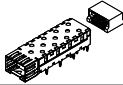
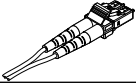
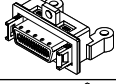
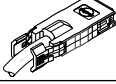
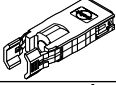
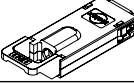
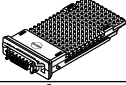
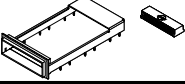
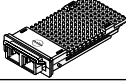
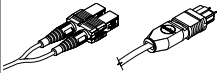
| Copper—2 Differential Pair | | | | |
|----------------------------|---|--|---|-------------------------|
| | Data Link | Product | Description | Series |
| 1X |  | HSSDC2 Board-Mount Receptacle Single Row HSSDC2 Board-Mount Receptacle Dual Row | Right Angle, InfiniBand Key | 74703 74780 |
| |  | HSSDC2 Cable Assembly Single Row, Loop Back HSSDC2 Cable Assembly Dual Row, Loop Back | Various Lengths, Equalized or Unequalized | 73939 74514 |
| |  | Cage-to-Cage SFP Patch Cables | Various Lengths, 0.3m to 10.0m | 73929 |
| |  | HSSDC2 Pluggable SFP Modules, Loop Back, Dust Plug | Active and Passive Transceivers | 74720 |
| |  | SFP Cages SFP Host Connectors SFP Cage and Connector Kit | Press-Fit, Solder Post and PCI Compliant 20-Position Right Angle SMT Press-Fit Cage with 20-Position Right Angle SMT Host Connector | 73927 74441 75082 |
| Optical | | | | |
| 1X |  | Dual LC Optical Cables | Cable Assemblies, Connectors and Adapters | 86025 |
| Copper—8 Differential Pair | | | | |
| | Data Link | Product | Description | Series |
| 4X |  | LaneLink™ Board-Mount Receptacle | Screw Mount or Solder Post with Latches | 91804 |
| |  | Cable Assemblies: 4X-to-4X, 4X-to-(4)1X, (3)4X-to-12X | Equalized or Unequalized with Latches | 92903 |
| |  | Squeeze Release Plug Kit | Plug Connector, Back Shells Equalized or Unequalized with Latches | 91534 |
| |  | Lanyard Plug Kit | Plug Connector, Back Shells Equalized or Unequalized with Lanyard Pull-Velcase System | 91942 |
| |  | Pluggable Module | XPAK Form Factor LaneLink I/O CX4 | 74732 |
| |  | Guide Frame for Pluggable Modules Host Connector | Press-Fit, Solder Post and PCI Compliant 70-Position Right Angle SMT | 74732 74441 |
| Optical | | | | |
| | Data Link | Product | Description | Series |
| 4X |  | Pluggable Module | XPAK Form Factor Dual SC I/O LX4 | 86993 |
| |  | Dual SC Optical Cables MPO Optical Cables | Single or Multimode Single 12 Fiber Ribbon Cable Assemblies | 86290 86282 |

* InfiniBand is a trademark of the InfiniBand™ Trade Association

InfiniBand* I/O Interconnect Solutions

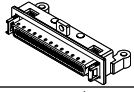
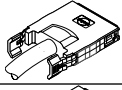
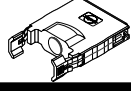
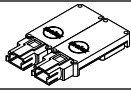
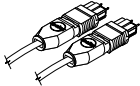
| Copper—24 Differential Pair | | | | |
|-----------------------------|---|---|--|--------|
| | Data Link | Product | Description | Series |
| 12X |  | LaneLink™ Board-Mount Receptacle | Screw Mount or Solder Post with Latches | 91525 |
| |  | Cable Assemblies: 12X-to-12X, 12X-to-(12)1X, 12X-to-(3)4X | Equalized or Unequalized with Latches | 92903 |
| |  | Plug Kit | Plug Connector, Back Shells Equalized or Unequalized with Latches | 91534 |
| Optical | | | | |
| | Data Link | Product | Description | Series |
| 12X |  | ParaLink-P™ Pluggable Module | 12 Channel Parallel Optical Link, TX and RX | 86991 |
| |  | MPO Optical Cables | Dual 12 Fiber Ribbon Cable Assemblies | 86282 |

* InfiniBand is a trademark of the InfiniBand™ Trade Association

1.27mm (.050") Pitch HSSDC2 Copper Cable Assembly

73939

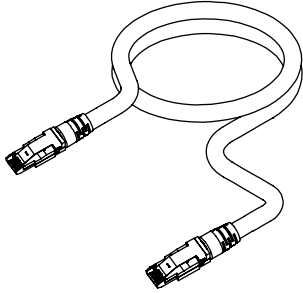

Features and Benefits

- Compliant with HSSDC2 MSA
- Data rates up to 2.5 Gbps
- Keyed for Fibre Channel and InfiniBand* receptacles to prevent mismatching
- Positive latching to prevent accidental disengagement
- 360° shielding

Reference Information

Packaging: Bag
Mates With: 74703
Use With: 74720
Designed In: Millimeters

Electrical

Voltage: 30V
Current: 0.5A

Mechanical

Mating Force: 6.7 lbf max.
Unmating Force: 3.37 lbf max.
Durability: 250 cycles

Physical

Housing: Zinc diecast
Housing plating: Nickel

| Length | Order No. | | Lead-free |
|--------------|----------------------------|----------------------------|-----------|
| | HSSDC2—Fibre Channel | HSSDC2—InfiniBand | |
| 0.5m (1.64') | 73939-1001 | 73939-2001 | Yes |
| 1.0m (3.28') | 73939-1002 | 73939-2002 | |
| 2.0m (6.56') | 73939-1003 | 73939-2003 | |
| 3.0m (9.84') | 73939-1004 | 73939-2004 | |
| 5.0m (16.4') | 73939-1005 | 73939-2005 | |
| 10m (32.80') | 73939-1006 | 73939-2006 | |

* InfiniBand is a trademark of the InfiniBand Trade Association.

0.50mm (.020") Pitch LaneLink™ Receptacle

91804
4x Latch

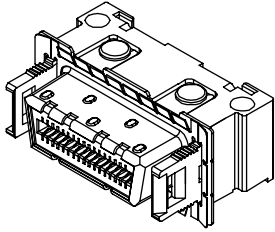

Features and Benefits

- Landing area allows for automatic placement
- Optional panel mount enables screw-attach of diecast frame to panel, providing additional strain relief
- Solder post options available (2 or 4 posts)
- Latching mechanism complies with InfiniBand* and Ethernet
- Rear EMI shield available
- Locking panel available

Reference Information

Product Specification: PS-91525-001
Packaging: Tray or tape and reel
Mates With: 91635 and 92903
Use With: 91789 EMI shield and 91532 locking panel
Designed In: Millimeters

Electrical

Voltage: 30V
Current: 0.5A
Contact Resistance: 80 milliohms max.
Dielectric Withstanding Voltage: 300V AC
Insulation Resistance: 1000 Megohms min.

Mechanical

Contact Insertion Force: 5.00N (1.12 lb)
Mating Force: 55.50N (12.48 lb) max.
Unmating Force: 7.00N (1.57 lb) min.
Normal Force: 0.50N (0.11 lb)
Durability: 250 cycles

Physical

Housing: Glass-filled LCP, UL 94V-0
Contact: Phosphor Bronze
Plating: Contact Area—Gold over Palladium Nickel
Solder Tail Area—Tin
Underplating: Nickel

I/O Products

N

| Order No. | Rear Mounts | Solder Posts | Panel Mount | Packaging | Lead-free |
|----------------------------|-------------|--------------|-------------|---------------|-----------|
| 91804-0411 | No | No | No | Tray | Yes |
| 91804-0413 | Yes | | Yes | | |
| 91804-0415 | | | | | |
| 91804-0417 | No | | No | | |
| 91804-0451 | | 2 (Note 1) | | | |
| 91804-0453 | Yes | 4 (Note 1) | | | |
| 91804-0455 | | 4 (Note 1) | Yes | | |
| 91804-0457 | No | 2 (Note 1) | No | | |
| 91804-0461 | | 2 (Note 2) | | | |
| 91804-0463 | Yes | 4 (Note 2) | Yes | | |
| 91804-0465 | | 4 (Note 2) | No | | |
| 91804-0467 | No | 2 (Note 2) | Yes | | |
| 91804-0491 | | 2 (Note 3) | No | | |
| 91804-0493 | Yes | 4 (Note 3) | | | |
| 91804-0495 | | 4 (Note 3) | Yes | | |
| 91804-0497 | No | 2 (Note 3) | | | |
| 91804-8411 | | No | No | Tape and Reel | Yes |
| 91804-8413 | Yes | | Yes | | |
| 91804-8415 | | | | | |
| 91804-8417 | No | | No | | |
| 91804-8451 | | 2 (Note 1) | | | |
| 91804-8453 | Yes | 4 (Note 1) | | | |
| 91804-8455 | | 4 (Note 1) | Yes | | |
| 91804-8457 | No | 2 (Note 1) | No | | |
| 91804-8461 | | 2 (Note 2) | | | |
| 91804-8463 | Yes | 4 (Note 2) | Yes | | |
| 91804-8465 | | 4 (Note 2) | No | | |
| 91804-8467 | No | 2 (Note 2) | Yes | | |
| 91804-8491 | | 2 (Note 3) | No | | |
| 91804-8493 | Yes | 4 (Note 3) | | | |
| 91804-8495 | | 4 (Note 3) | Yes | | |
| 91804-8497 | No | 2 (Note 3) | | | |

*InfiniBand is a trademark of the InfiniBand™ Trade Association.

Note 1: Solder post length 2.30mm (.092")

Note 2: Solder post length 3.30mm (.132")

Note 3: Solder post length 4.30mm (.172")

0.50mm (.020") Pitch LaneLink™ Receptacle

91803
4x Jackscrew

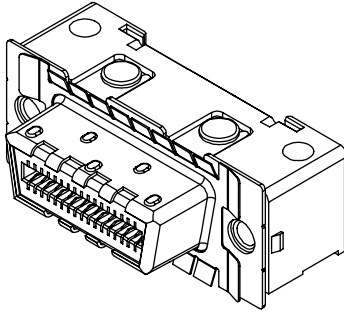

Features and Benefits

- Landing area allows for automatic placement
- Optional panel mount enables screw-attach of diecast frame to panel, providing additional strain relief
- Solder post options available (2 or 4 posts)
- Jackscrew mechanism complies with SAS, SATA and Fibre Channel
- Rear EMI shield available

Reference Information

Product Specification: PS-91525-001
Packaging: Tray or tape and reel
Mates With: 91659 and 92903
Use With: 91789 EMI cover and 91619 Standoff
Designed In: Millimeters

Electrical

Voltage: 30V
Current: 0.5A
Contact Resistance: 80 milliohms max.
Dielectric Withstanding Voltage: 300V AC
Insulation Resistance: 1000 Megohms min.

Mechanical

Contact Insertion Force: 5.00N (1.12 lb)
Mating Force: 55.50N (12.48 lb) max
Unmating Force: 7.00N (1.57 lb) min
Normal Force: 0.50N (0.11 lb)
Durability: 250 cycles

Physical

Housing: Glass-filled LCP, UL 94V-0
Contact: Phosphor Bronze
Plating: Contact Area—Gold over Palladium Nickel
Solder Tail Area—Tin
Underplating—Nickel

| Order No. | Rear Mounts | Solder Posts | Packaging | Lead-free | | |
|----------------------------|-------------|--------------|-----------|-----------|---------------|-----|
| 91803-0411 | No | No | Tray | Yes | | |
| 91803-0413 | Yes | | | | | |
| 91803-0415 | No | 2 (Note 1) | | | | |
| 91803-0417 | Yes | 4 (Note 1) | | | | |
| 91803-0465 | No | 2 (Note 2) | | | | |
| 91803-0467 | Yes | 4 (Note 2) | | | | |
| 91803-0495 | No | 2 (Note 3) | | | | |
| 91803-0497 | Yes | 4 (Note 3) | | | | |
| 91803-8411 | No | No | | | Tape and Reel | Yes |
| 91803-8413 | Yes | | | | | |
| 91803-8415 | No | 2 (Note 1) | | | | |
| 91803-8417 | Yes | 4 (Note 1) | | | | |
| 91803-8465 | No | 2 (Note 2) | | | | |
| 91803-8467 | Yes | 4 (Note 2) | | | | |
| 91803-8495 | No | 2 (Note 3) | | | | |
| 91803-8497 | Yes | 4 (Note 3) | | | | |

Note 1: Solder post length 2.30mm (.092")
Note 2: Solder post length 3.30mm (.132")
Note 3: Solder post length 4.30mm (.172")

0.50mm (.020") Pitch LaneLink™ Receptacle

91525
12x Latch

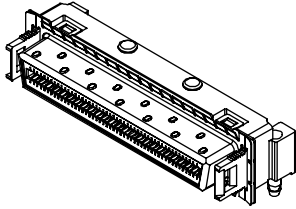

Features and Benefits

- Diecast frame with latches provides strain relief of cable to receptacle and isolates cable loads from SMT tails
- Optional panel mount enables screw-attach of diecast frame to panel, providing additional strain relief
- Solder post options available (2 or 4 posts)
- Latching mechanism complies with InfiniBand* and Ethernet
- Latching panel available

Reference Information

Product Specification: PS-91525-001
Packaging: Tray or Tape and reel
Mates With: 92903 and 91635
Use With: 91532 locking panel
Designed In: Millimeters

Electrical

Voltage: 30V
Current: 0.5A
Contact Resistance: 80 milliohms max.
Dielectric Withstanding Voltage: 300V AC
Insulation Resistance: 1000 Megohms min.

Mechanical

Mating Force: 73N (16.41 lb) max.
Unmating Force: 10.5N (2.36 lb) min.
Normal Force: 0.50N (0.11 lb)
Durability: 250 cycles

Physical

Housing: Glass-filled LCP, UL 94V-0
Contact: Phosphor Bronze
Plating: Contact Area—Gold over Palladium Nickel
Solder Tail Area—Tin
Underplating: Nickel

I/O Products

N

| Order No. | Rear Mounts | Panel Mount | Solder Posts | Packaging | Lead-free | | |
|----------------------------|-------------|-------------|--------------|-----------|-----------|---------------|-----|
| 91525-1211 | No | No | No | Tray | Yes | | |
| 91525-1213 | Yes | No | | | | | |
| 91525-1215 | Yes | Yes | | | | | |
| 91525-1217 | No | Yes | | | | | |
| 91525-1251 | No | No | 2 (Note 1) | | | | |
| 91525-1253 | Yes | No | 4 (Note 1) | | | | |
| 91525-1255 | Yes | Yes | 4 (Note 1) | | | | |
| 91525-1257 | No | Yes | 2 (Note 1) | | | | |
| 91525-1261 | No | No | 2 (Note 2) | | | | |
| 91525-1263 | Yes | No | 4 (Note 2) | | | | |
| 91525-1265 | Yes | Yes | 4 (Note 2) | | | | |
| 91525-1267 | No | Yes | 2 (Note 2) | | | | |
| 91525-1291 | No | No | 2 (Note 3) | | | | |
| 91525-1293 | Yes | No | 4 (Note 3) | | | | |
| 91525-1295 | Yes | Yes | 4 (Note 3) | | | | |
| 91525-1297 | No | Yes | 2 (Note 3) | | | | |
| 91525-8211 | No | No | No | | | Tape and Reel | Yes |
| 91525-8213 | Yes | No | | | | | |
| 91525-8215 | Yes | Yes | | | | | |
| 91525-8217 | No | Yes | | | | | |
| 91525-8251 | No | No | 2 (Note 1) | | | | |
| 91525-8253 | Yes | No | 4 (Note 1) | | | | |
| 91525-8255 | Yes | Yes | 4 (Note 1) | | | | |
| 91525-8257 | No | Yes | 2 (Note 1) | | | | |
| 91525-8261 | No | No | 2 (Note 2) | | | | |
| 91525-8263 | Yes | No | 4 (Note 2) | | | | |
| 91525-8265 | Yes | Yes | 4 (Note 2) | | | | |
| 91525-8267 | No | Yes | 2 (Note 2) | | | | |
| 91525-8291 | No | No | 2 (Note 3) | | | | |
| 91525-8293 | Yes | No | 4 (Note 3) | | | | |
| 91525-8295 | Yes | Yes | 4 (Note 3) | | | | |
| 91525-8297 | No | Yes | 2 (Note 3) | | | | |

Note 1: Solder post length 2.30mm (.092")

Note 2: Solder post length 3.30mm (.132")

Note 3: Solder post length 4.30mm (.172")

* InfiniBand is a trademark of the InfiniBand(SM) Trade Association.

0.50mm (.020") Pitch LaneLink™ Receptacle

91629
12x Jackscrew

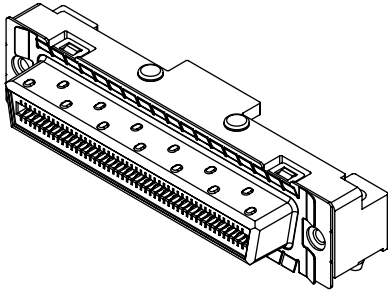

Features and Benefits

- Diecast frame with latches provides strain relief of cable to receptacle and isolates cable loads from SMT tails
- Solder post options available (2 or 4 posts)
- Jackscrew mechanism complies with SAS, SATA and Fibre Channel

Reference Information

Product Specification: PS-91525-001
Packaging: Tray or tape and reel
Mates With: 92903 and 91659
Use With: 91619 Standoff
Designed In: Millimeters

Electrical

Voltage: 30V
Current: 0.5A
Contact Resistance: 80 milliohms max.
Dielectric Withstanding Voltage: 300V AC
Insulation Resistance: 1000 Megohms min.

Mechanical

Mating Force: 73N (16.41 lb) max.
Unmating Force: 10.5N (2.36 lb) min.
Normal Force: 0.50N (0.11 lb)
Durability: 250 cycles

Physical

Housing: Glass-filled LCP, UL 94V-0
Contact: Phosphor Bronze
Plating: Contact Area—Gold over Palladium Nickel
Solder Tail Area—Tin
Underplating: Nickel

| Order No. | Rear Mounts | Solder Posts | Packaging | Lead-free |
|----------------------------|-------------|--------------|---------------|-----------|
| 91629-1211 | No | No | Tray | Yes |
| 91629-1213 | Yes | No | | |
| 91629-1215 | No | 2 (Note 1) | | |
| 91629-1217 | Yes | 4 (Note 1) | | |
| 91629-1265 | No | 2 (Note 2) | | |
| 91629-1267 | Yes | 4 (Note 2) | | |
| 91629-1295 | No | 2 (Note 3) | Tape and Reel | |
| 91629-1297 | Yes | 4 (Note 3) | | |
| 91629-1211 | No | No | | |
| 91629-1213 | Yes | No | | |
| 91629-1215 | No | 2 (Note 1) | | |
| 91629-1217 | Yes | 4 (Note 1) | | |
| 91629-1265 | No | 2 (Note 2) | | |
| 91629-1267 | Yes | 4 (Note 2) | | |
| 91629-1295 | No | 2 (Note 3) | | |
| 91629-1297 | Yes | 4 (Note 3) | | |

Note 1: Solder post length 2.30mm (.092")
Note 2: Solder post length 3.30mm (.132")
Note 3: Solder post length 4.30mm (.172")

LaneLink™ Standoff

91619
M2-by-0.4mm
Internal Thread

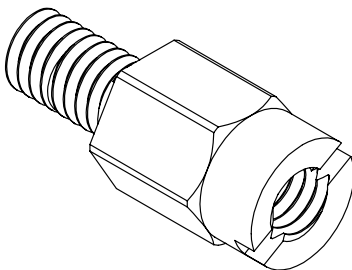

Features and Benefits

- Hex and Flathead compatible
- NYLOK™ screw retention to help secure to connector

Reference Information

Mates With: 92903 and 91659
Use With: 91629 and 91803
Packaging: Bag
Designed In: Millimeters

Mechanical

Recommended Torque: 0.3Nm max

Physical

Contact: Copper Alloy
Plating: Nickel

| Order No. | Lead-free |
|----------------------------|-----------|
| 91619-0001 | Yes |

LaneLink™ Latch Connector

91532 Locking Panel

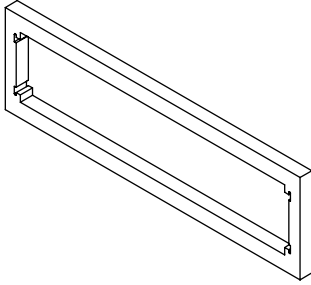

Features and Benefits

- Locking panel is used to compress the gasket between the connector and the chassis of the application
- Improves the EMI/EMC performance

Reference Information

Packaging: Bag
Use With: 91525 and 91804
Designed In: Millimeters

Mechanical

Lock to Mating Part: Self-clinching

Physical

Housing: Stainless Steel

| Lanes | Order No. | Panel Mount | Lead-free |
|-------|----------------------------|-------------|-----------|
| 4 | 91532-0005 | Yes | Yes |
| | 91532-0007 | No | |
| 12 | 91532-0001 | Yes | |
| | 91532-0003 | No | |

I/O Products

LaneLink™ EMI Cover (Rear)

91789 For 4X Receptacles

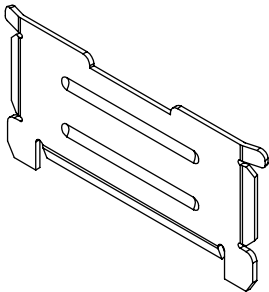

Features and Benefits

- Improves EMI/EMC performance
- Inserted after reflow to facilitate solder joint inspection
- Positive locking feature

Reference Information

Use with: 91803 and 91804
Packaging: Bag
Designed In: Millimeters

Physical

Material: Stainless steel

| Order No. | Lead-free |
|----------------------------|-----------|
| 91789-0001 | Yes |

0.50mm (.020") Pitch LaneLink™ Cable Assembly for DDR IB 74595/111000 4x/12x Dual Data Rate (DDR) IB

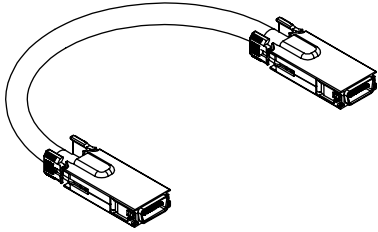

Features and Benefits

- New paddle card design provides improved signal integrity and overall lower cost
- Redesigned back shell reduces EMI emissions
- Data rates of up to 5 Gbps doubles standard InfiniBand* rates
- Multiple latching options provide greater flexibility in system design

Reference Information

Packaging: Bag
Mates With: 4x—91803, 91804
12x—91525
Designed In: Millimeters

Electrical

Voltage: 30V AC
Current: 0.5A

Mechanical

Mating Force: 4x—55.50N (12.47 lbf)
12x—73.0N (16.41 lbf)
Unmating Force: 4x—49.0N (11.01 lbf)
12x—59.0N (13.26 lbf)
Durability: 250 cycles

Physical

Housing: Zinc die cast
Contact: Gold
Housing Plating: Nickel

| Order No. | Length | Cable | Latch Style | Lead-free |
|-----------------------------|----------------|-------|-------------|-----------|
| 74595-1005 | 0.5m (1.64') | 4x | Squeeze | Yes |
| 74595-1010 | 1.0m (3.28') | | | |
| 74595-1030 | 3.0m (9.84') | | | |
| 74595-1050 | 5.0m (16.40') | | | |
| 74595-1100 | 10.0m (32.80') | | | |
| 74595-5005 | 0.5m (1.64') | 4x | Lanyard | |
| 74595-5010 | 1.0m (3.28') | | | |
| 74595-5030 | 3.0m (9.84') | | | |
| 74595-5050 | 5.0m (16.40') | | | |
| 74595-5100 | 10.0m (32.80') | | | |
| 111000-1005 | 0.5m (1.64') | 12x | Squeeze | |
| 111000-1010 | 1.0m (3.28') | | | |
| 111000-1030 | 3.0m (9.84') | | | |
| 111000-1050 | 5.0m (16.40') | | | |
| 111000-1100 | 10.0m (32.80') | | | |

*InfiniBand is a trademark of the InfiniBand Trade Association.

www.molex.com/product/io/lanelink.html

0.50mm (.020") Pitch LaneLink™ InfiniBand* Cable Assembly

74506
4X Cable

74509
12X Cable

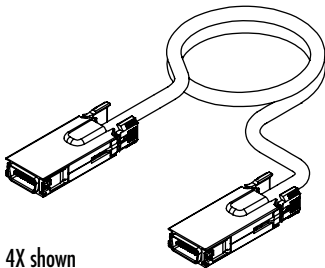

4X shown

Features and Benefits

- Squeeze-to-release latch provides user-friendly, positive latch/unlatch from the PCB connector
- Sturdy diecast backshell provides EMI protection
- Total InfiniBand solution with plug and connector (91525)
- Lengths up to 20m with equalization and pre-emphasis (10m standard InfiniBand)
- High performance production test rack provides 100% testing to InfiniBand industry standards

Reference Information

Packaging: Bag
Mates With: 91525
Use With: 74735 and 74739
Designed In: Millimeters

Electrical

Voltage: 30V AC
Current: 0.5A

Mechanical

Mating Force: 55.5N (12.48 lbf)
Unmating Force: 49.0N (11.02 lbf)
Durability: 250 cycles

Physical

Housing: Zinc diecast
Contact: Gold flash
Housing Plating: Nickel

| Length | Order No. | Cable | Equalized | Lead-free |
|----------------|----------------------------|-------|-----------|-----------|
| 0.5m (1.64') | 74506-3001 | 4x | No | Yes |
| 1.0m (3.28') | 74506-3002 | | | |
| 8.0m (26.24') | 74506-3105 | | Yes | |
| 10.0m (32.80') | 74506-3107 | | | |
| 0.5m (1.64') | 74509-0001 | 12x | No | |
| 1.0m (3.28') | 74509-0002 | | | |

Note: Additional lengths available on sales drawing shown on website.

* InfiniBand is a trademark of the InfiniBand Trade Association.

0.50mm (.020") Pitch LaneLink™ 10 Gbase—CX4 Cable Assembly

74526
4X

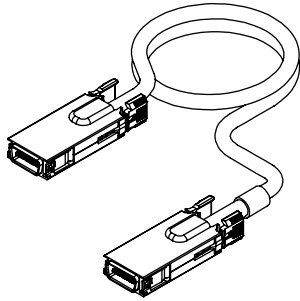

| Length | Order No. | Lead-free |
|----------------|----------------------------|-----------|
| 1.0m (3.28') | 74526-1002 | Yes |
| 15.0m (49.20') | 74526-1007 | |

Note: Additional lengths available on sales drawing shown on website.

Features and Benefits

- Squeeze-to-release latch provides user-friendly, positive latch/unlatch from the PCB connector
- Sturdy diecast backshell provides EMI protection
- Total CX4 solution with plug and connector (91525)
- Standard 4x interface mates with XPAK (74739), and X2 (74735) copper transceivers
- Lengths greater than 15m can be achieved with the use of pre-emphasis on the board-side silicon
- High performance production test rack provides 100% eye pattern testing

Reference Information

Packaging: Bag
Mates With: 91525
Use With: 74735 and 74739
Designed In: Millimeters

Electrical

Voltage: 30V AC
Current: 0.5A

Mechanical

Mating Force: 55.5N (12.49 lbf)
Unmating Force: 49.0N (11.02 lbf)
Durability: 250 cycles

Physical

Housing: Zinc diecast
Contact: Gold flash
Housing Plating: Nickel

0.50mm (.020") Pitch LaneLink™ SAS and SATA I/O External Multilane Cable Assembly

74527 – SAS
74530 – SATA I/O
4X LaneLink™ Cable

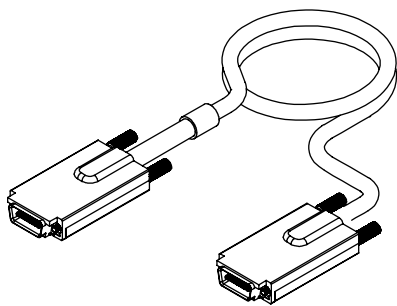

| Length | Order No. | Product Family | Lead-free |
|--------------|----------------------------|----------------|-----------|
| 0.5m (1.64') | 74527-3001 | SAS | Yes |
| 1.0m (3.28') | 74527-3002 | | |
| 3.0m (9.84') | 74527-3004 | | |
| 5.0m (16.4') | 74527-3006 | | |
| 0.5m (1.64') | 74530-0001 | SATA | |
| 1.0m (3.28') | 74530-0002 | | |
| 3.0m (9.84') | 74530-0003 | | |
| 5.0m (16.4') | 74530-0005 | | |

Note: Additional lengths available on sales drawing shown on website.

Features and Benefits

- Sturdy jackscrew hardware provides user with guaranteed mating to the PCB connector
- Diecast back shell provides EMI protection
- Total SAS and SATA I/O system solution with industry-standard compatible interface and connector (91659)
- Molex LaneLink cable is SFF8470 compliant
- Lengths greater than 15m can be achieved with the use of pre-emphasis on the board side silicon
- High performance production test rack provides 100% eye pattern testing to SAS/SATA standards

Reference Information

Packaging: Bag
Mates With: 91659
Use With: 74735 and 74739
Designed In: Millimeters

Electrical

Voltage: 30V AC
Current: 0.5A

Mechanical

Mating Force: 55.5N (12.48 lbf)
Unmating Force: 49.0N (11.02 lbf)
Durability: 250 cycles

Physical

Housing: Zinc diecast
Contact: Gold flash
Housing Plating: Nickel

0.50mm (.020")/ 1.27mm (.050") Pitch LaneLink™ to SATA Cable Assembly External Multi-Lane 4X to 1X SATA Style 4X Jackscrew

74527

**4X SAS LaneLink to
(4)X1 SATA Cable
(SFF-8470 to IX SATA)**

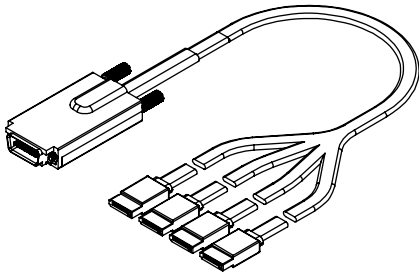

Features and Benefits

- Interface adapter cable provides the ability to mate between various SAS and SATA interconnects with existing systems that use SFF-8470
- Jackscrew option complies with SFF-8470, which meets SFF committee standard specifications
- Latch version of internal plug provides secure mating to the receptacle via the receptacles metal latch and the latching windows of the plug

Reference Information

Packaging: Bag
Mates With: Internal—47080, 67490, 67800
External—91659
Designed In: Millimeters

Electrical

Voltage: 30V AC
Current: 0.5A

Mechanical

External SFF-8470
Mating Force: 55.5N (12.48 lbf)
Unmating Force: 49.0N (11.02 lbf)
Durability: 250 cycles

Internal SATA

Mating Force: 45N per circuit (10.12 lbf)
Unmating Force: 10N per circuit (2.25 lbf)
Durability: 500 cycles

Physical

External SFF-8470
Housing: Zinc diecast
Housing Plating: Nickel
PCB Contact: Gold

Internal SATA

Housing: Black glass-filled thermoplastic, UL 94V-0
Contact: 30µ" min. Gold over Nickel

| Length | Order No. | Description | Pinout Orientation | Lead-free |
|--------------|---------------------------|-----------------------------|----------------------|-----------|
| 0.5m (1.64') | 74527-001 | Straight (P1 to P1) pinout | Transmit to Transmit | Yes |
| 1.0m (3.28') | 74527-002 | | | |
| 0.5m (1.64') | 74527-101 | Crossover (P1 to P4) pinout | Transmit to Receive | |
| 1.0m (3.28') | 74527-102 | | | |

www.molex.com/hpc/

0.50mm (.020") Pitch LaneLink™ Latch Plug kit

91635

4x and 12x

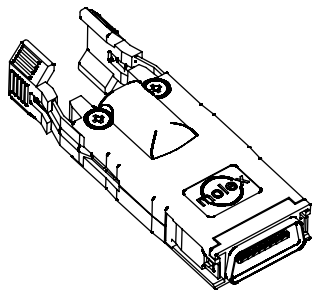

Features and Benefits

- Paddle card
- Latch levers provide user-friendly positive latch opening before unplugging cable connector from receptacle
- Audible click confirms mating to receptacle
- 100 ohms impedance
- 8 and 24 differential pair available

Reference Information

Product Specification: PS-91525-001
Packaging: Bag
Mates with: 91525 and 91804
Designed in: Millimeters

Electrical

Voltage: 30V
Current: 0.5A
Contact Resistance: 80 milliohms max.
Dielectric Withstanding Voltage: 300V AC
Insulation Resistance: 1000 Megohms min.

Mechanical

Mating Force: 12x—73N (16.41 lb) max.
Unmating Force: 12x—10.5N (2.36 lb) min.
Normal Force: 0.50N (0.11 lb)
Durability: 250 cycles

Physical

Contact: Phosphor Bronze
Plating: Contact Area—Gold over Palladium Nickel
Solder Tail Area—Tin
Underplating: Nickel

| Lanes | Order No. | Wire Gauge | Lead-free |
|-------|----------------------------|------------|-----------|
| 4 | 91635-1020 | 24 AWG | Yes |
| | 91635-1021 | 26 AWG | |
| | 91635-1022 | 28 AWG | |
| 12 | 91635-1010 | 24 AWG | |
| | 91635-1011 | 26 AWG | |
| | 91635-1012 | 28 AWG | |

0.50mm (.020") Pitch LaneLink™ Jack Screw Plug Kit

91659
4x and 12x

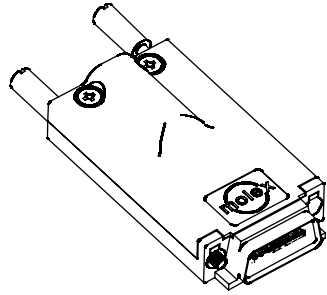

Features and Benefits

- Paddle card
- 100 ohms impedance
- 8 and 24 differential pair available

Reference Information

Product Specification: PS-91525-001
Packaging: Bag
Mates With: 91629 and 91803
Designed In: Millimeters

Electrical

Voltage: 30V
Current: 0.5A
Contact Resistance: 80 milliohms max.
Dielectric Withstanding Voltage: 300V AC
Insulation Resistance: 1000 Megohms min.

Mechanical

Mating Force: 12x—73N (16.41 lb) max.
Unmating Force: 12x—10.5N (2.36 lb) min.
Normal Force: 0.50N (0.11 lb)
Durability: 250 cycles

Physical

Contact: Phosphor Bronze
Plating: Contact Area—Gold over Palladium Nickel
Solder Tail Area—Tin
Underplating: Nickel

| Lanes | Order No. | Wire Gauge | Lead-free |
|-------|----------------------------|------------|-----------|
| 4 | 91659-1020 | 24 AWG | Yes |
| | 91659-1021 | 26 AWG | |
| | 91659-1022 | 28 AWG | |
| 12 | 91659-1010 | 24 AWG | |
| | 91659-1011 | 26 AWG | |
| | 91659-1012 | 28 AWG | |

www.molex.com/product/io/lanelink.html

I/O Products

N

XPAK 10 Gbps 74732 XPAK Guide Rail

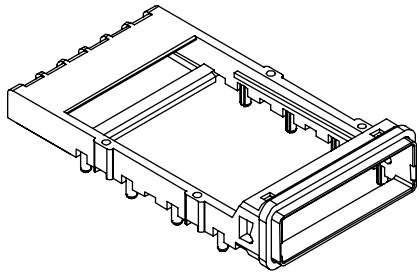

Features and Benefits

- Cable transmits 10 Gbps data up to 15m over copper cable, enabling high speed data transmission
- Transceiver is able to be installed or removed without powering down
- Transceiver is compliant with XPAK MSA and designed to meet Gigabit Ethernet standards IEEE 802.3ak for CX4 and IEEE 802.3ae for XAUI
- Positive latching on the guide frame provides proper transceiver retention
- Threaded screw holes help increase retention to the PCB
- Guide rail compliance with MSA standard ensures proper mating with industry standard products

Reference Information

Packaging: Transceiver—Bag
Guide Frame—Tray
Transceiver Mates With: Host Connector (74441)
CX4 Cable Assembly (74526)
Designed In: Millimeters

Electrical

Transceiver
Voltage: 3.3V at 567mA, 1.5V at 1554mA
Current: 3.3V at 567mA, 1.5V at 1554mA

Mechanical

Transceiver
Mating Force: Min.—20N (4.5 lbf)
Max.—40N (9 lbf), 80N (18 lbf) max. allowed by MSA
Unmating Force: Min.—8N (1.79 lbf)
Max.—35N (7.9 lbf)
Durability: 100 cycles

Physical

Transceiver
Housing: Zinc
PCB contact: 0.76µm (30µ") Gold
PCB Thickness: 1.00mm (.393") ± 0.10mm (.004")

Guide Frame

Housing: Zinc Alloy
Plating: Nickel

| Order No. | Description | Lead-free |
|----------------------------|-------------|-----------|
| 74732-0220 | Guide Rail | Yes |

Ultra+™ VHDCI Connector System

Molex's 0.80mm (.031") Ultra+ VHDCI Connector System is a leader among the next generation of high density connectors. These 68-circuit connectors are designed for high performance memory transfer applications, supporting the latest SCSI-style interfaces. They offer greatly increased density compared to existing SCSI connectors styles. They are also well suited for other high density I/O needs.

These connectors enable two side-by-side ports, allowing cards to support up to 30 drives. Stacked receptacles support up to 60 drives. They offer a tremendous advantage over the current SCSI-3 connectors that allow only one port on standard add-in cards.

Molex's Ultra+ VHDCI connectors feature easy-to-use cable assembly and superior leaf/ribbon style contacts. They meet the Small Form Factor and EIA Standards.

Molex also has standard high density SCSI-3 connectors for use with the new Ultra+ VHDCI cable formats.

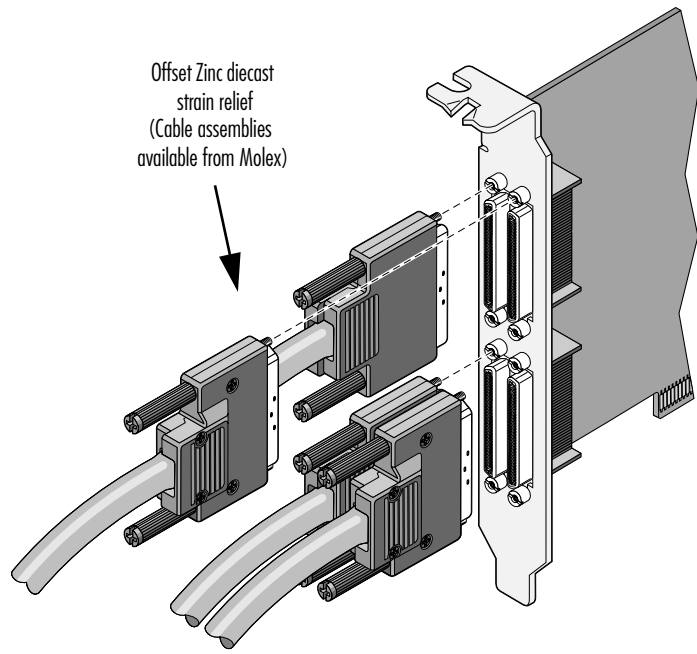

Typical 4-Port Add-In Card

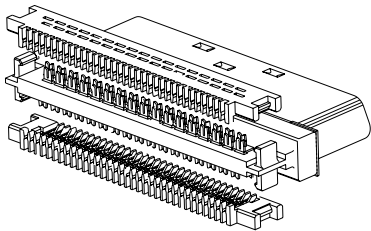

71425
IDT Plug

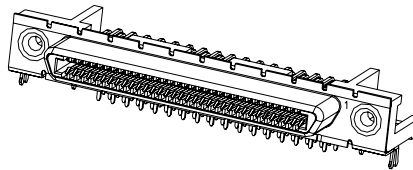

71430
Right Angle Receptacle

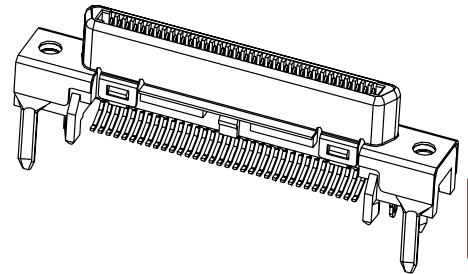

73776
Vertical SMT Receptacle

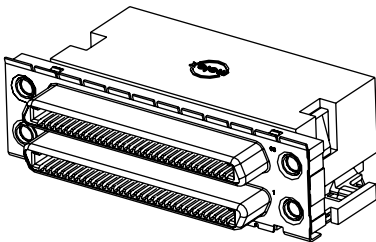

74337
Right Angle
Dual Stack

I/O Products

N

0.80mm (.031") Pitch Ultra+™ VHDCI Connector System

Molex's Ultra+ VHDCI connector system is a leader among the next generation of high-density I/O interconnects. These 68-circuit connectors are designed for high performance memory transfer applications, supporting the latest SCSI-style interfaces. They offer greatly increased density compared to existing SCSI connector styles. They are also well suited for other high-density I/O needs.

All of the VHDCI connectors feature superior leaf/ribbon style contacts and meet EIA and SFF industry standard specifications to ensure intermatability with conforming products.

These connectors enable 2 side-by-side ports on typical system add-in cards. The newest version of the VHDCI product line, the stacked receptacle, supports twice the density of the standard right-angle receptacle. Our multiple contact points for improved EMI/RFI performance.

I/O Products

N

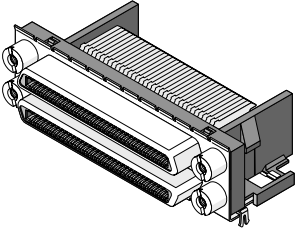
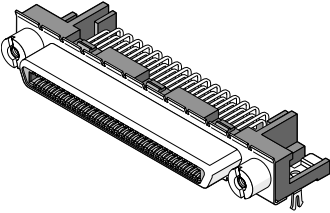
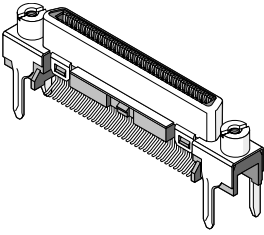
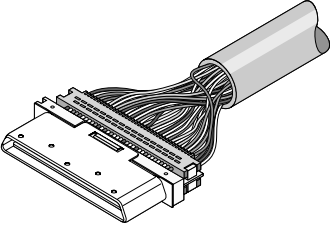
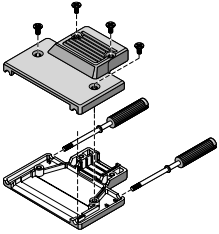
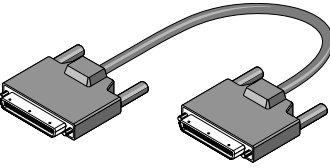
| Product | Description | Specifications | Series |
|---|---|--|--------|
|  | Stacked Right Angle Receptacle, Through Hole, With Enhanced Shield | 2.08-3.44mm (.082-.135") PC Tail Lengths, With or Without Screwlocks or Cover | 74337 |
|  | Right Angle Receptacle, Through Hole, With or Without Enhanced Shield | 2.08-2.71mm (.082-.107") PC Tail Lengths, Available With or Without Screwlocks | 71430 |
|  | Vertical Receptacle, SMT | Recommended PCB Thickness: 2.36mm (.093") PCB Ground Tabs Provide Mechanical Support, Available With or Without Screwlocks | 73776 |
|  | IDT Plug Kit, With Lacing Covers | Uses 28 and 30 AWG Ultra+ Cable | 71425 |
|  | Strain Relief Kit, Offset Zinc Diecast, Black or Nickel Finish | Complete Kit Includes: Upper Shell, Lower Shell, 2 Jackscrews, 2 Long Screws, and 2 Short Screws | 73796 |
|  | Cable Assemblies, Various Lengths | VHDCI to VHDCI | 79918 |
| | | VHDCI to SCSI | 79913 |

0.80mm (.031") Pitch Ultra™ VHDCI Receptacle

71430

Right Angle, Through Hole

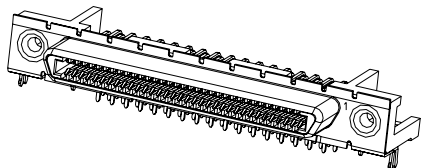

Features and Benefits

- Enhanced shield with multiple contact points for improved EMI/RFI shielding
- Conforms to EIA/SFF specifications to ensure intermateability with conforming products
- Shield design can eliminate reflow solder ground connection
- One-piece shield offers maximum ground integrity
Surface Mount Compatible

Reference Information

Product Specification: PSX-71425-9999
Packaging Type: Tube
UL File No.: E29179
CSA File No.: LR 19980-520
Mates With: 71425
Designed In: Millimeters

Electrical

Voltage: 30V
Current: .5A
Contact Resistance: 50 milliohms max.
Dielectric Withstanding Voltage: 250V
Insulation Resistance: 500 Megohms min.

Mechanical

Mating Force: .54N (55g)
Unmating Force: .15N (15g)
Durability: 500 cycles max.

Physical

Housing: Black high-temperature thermoplastic, UL 94V-0
Contact: Phosphor Bronze
Plating: Gold flash over Palladium Nickel

| Circuits | Order No. | PCB Thickness | PC Tail Length | Enhanced Ground Tabs | Screwlocks 71433-0002 | Lead-free |
|----------|----------------------------|---------------|----------------|----------------------|------------------------|-----------|
| 68 | 71430-0005 | 1.60 | 2.08 (.082) | Yes | No | Yes |
| | 71430-0007 | | | No | Yes, loose | |
| | 71430-0008 | | | Yes | Yes, loose | |
| | 71430-0011 | | | No | No | |
| | 71430-0101 | | | No | No | |
| | 71430-0004 | | | Yes | No | |
| | 71430-0006 | 2.36 | 2.71 (.107) | No | Yes, installed on part | |
| | 71430-0009 | | | Yes | Yes, installed on part | |
| | 71430-0010 | | | No | No | |
| | 71430-0016 | | | No | Yes, loose | |
| | 71430-0019 | | | Yes | Yes, loose | |
| | 71430-0268 | | | No | No | |

0.80mm (.031") Pitch Ultra™ VHDCI Wire-to-Board Receptacle

74337

Right Angle, Stacked, Through Hole

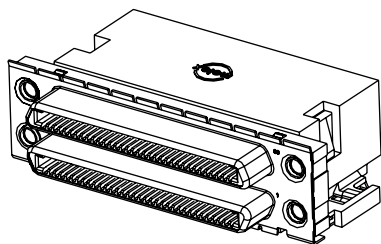

Features and Benefits

- Conforms to EIA/SFF specifications to ensure intermateability with conforming parts
- Gold flash over Palladium Nickel plating for a high durability/reliability interface
- Dual-stack, single-piece design provides space savings with one-step PCB processing
- Optional cover to protect from contact damage during handling
- One-piece enhanced face shield for improved EMI/RFI performance and simple ground termination process

Reference Information

Product Specification: PS-71425-9999
Packaging: Tray
UL File No.: E29179
CSA File No.: LR19980-5
Mates With: Ultra and VHDCI plug kit 71425
Designed In: Millimeters

Electrical

Voltage: 30V
Current: 0.5A
Contact Resistance: 50 milliohms max.
Dielectric Withstanding Voltage: 250V AC
Insulation Resistance: 500 Megohms min.

Mechanical

Mating Force: 0.49N (0.11 lb)
Unmating Force: 0.15N (0.03 lb)
Durability: 500 cycles

Physical

Housing: Black high-temperature thermoplastic, UL 94V-0
Contact: Phosphor Bronze
Plating: Gold flash over Palladium Nickel
PCB Thickness: 1.57 and 2.36mm (.062 and .093")

| Circuits | Order No. | | PCB Thickness | PC Tail Length | Cover | Screwlocks 71433-0002 | Lead-free | |
|----------|----------------------------|------------------------------|---------------|----------------|-------------|-----------------------|-----------|-------------------|
| | Snap Fit | Press Fit | | | | | | |
| 136 | 74337-0011 | 74337-0050 | 1.60 | 2.30 (.090) | Yes | No | Yes | |
| | 74337-0012 | *74337-0051* | | | | | | |
| | 74337-0015 | 74337-0060 | | | | | | |
| | 74337-0016 | 74337-0061 | | | | | | |
| | 74337-0037 | 74337-0066 | | | No | | | |
| | 74337-0038 | 74337-0053 | | | | | | |
| | 74337-0039 | 74337-0054 | | | | | | |
| | 74337-0040 | 74337-0063 | | | | | | |
| | 74337-0070 | 74337-0064 | Yes | | | | | |
| | 74337-0071 | 74337-0052 | | | | | | |
| | 74337-0072 | 74337-0062 | | | | | | |
| | 74337-0073 | 74337-0055 | | | | | | |
| | 74337-1038 | 74337-0065 | 2.36 | 3.44 (.135) | No | Yes, loose | | |
| | 74337-1038 | 74337-1054 | | | | | | |
| | | | | 1.60 | 2.08 (.082) | Yes | | Installed on Part |

* Without enhanced shield and ground tabs

0.80mm (.031") Pitch Ultra+™ VHDCI

73776
Vertical, SMT

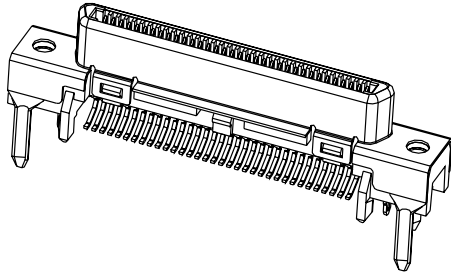

Features and Benefits

- Compatible with IR/vapor phase reflow process
- Conforms to EIA/SFF specifications to ensure intermateability with conforming products
- Through hole solder lead provides mechanically robust interface
- One-piece shield offers maximum ground integrity

Reference Information

Product Specification: PSX-71425-9999
Packaging: Tube
UL File No.: E29179
CSA File No.: LR19980-520
Mates With: 71425
Designed In: Millimeters

Electrical

Voltage: 30V
Current: .50A max.
Contact Resistance: 50 milliohms max.
Dielectric Withstanding Voltage: 250V
Insulation Resistance: 500 Megohms min.

Mechanical

Mating Force: 54N (55g)
Unmating Force: 1.5N (15g)
Durability: 500 cycles max.

Physical

Housing: Black high-temperature thermoplastic, 94V-0
Contact: Phosphor Bronze
Plating: Gold flash over Palladium Nickel

| Circuits | Order No. | Description | Lead-free |
|----------|----------------------------|--|-----------|
| 68 | 73776-0101 | Without screwlock kit | Yes |
| | 73776-0201 | With screwlock kit 71433-0002 included | |

0.80mm (.031") Pitch Ultra+™ VHDCI Plug Kit

N 71425
IDT

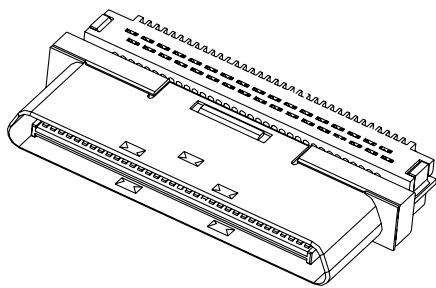

Features and Benefits

- Cable assemblies available from Molex
- 73796 backshell kit available
- Conforms to EIA/SFF specifications to ensure intermateability with conforming products
- Semi-automatic tooling available, which maximizes termination efficiency
- Insert molded design for rugged mating interface
- Narrow terminated profile that permits 2 wire termination process for all applications
- Works for both straight and offset cable applications
- Designed to terminate 30 gauge, 34 pair ultra style cables

Reference Information

Product Specification: PSX-71425-9999
Tooling Information: Raptor 2 or manual termination press
UL File No.: E29179
CSA File No.: LR 19980-520
Mates With: 71430, 73776 and 74337
Assembled with: 73796
Designed In: Millimeters

Electrical

Voltage: 30V
Current: .5A
Contact Resistance: 50 milliohms max.
Dielectric Withstanding Voltage: 250V
Insulation Resistance: 500 Megohms min.

Mechanical

Mating Force: .54N (55g)
Unmating Force: .15N (15g)
Durability: 500 min.

Physical

Housing: 94V-0, thermoplastic
Contact: Phosphor Bronze
Plating: Gold Flash over Palladium Nickel

| Circuits | Order No. | Lead-free |
|----------|----------------------------|-----------|
| 68 | 71425-3001 | Yes |

Includes plug and wire covers

0.80mm (.031") Pitch Ultra™ VHDCI Strain Relief

73796

Offset Zinc Die Cast

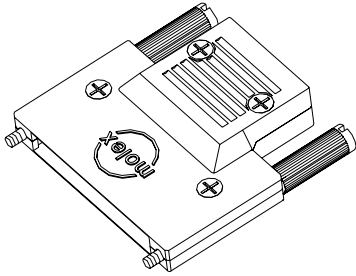

| Order No. | | Lead-free |
|----------------------------|----------------------------|-----------|
| Black | Nickel | |
| 73796-3001 | 73796-3002 | Yes |

Kit comes complete: 1 upper shell, 1 lower shell, 2 jackscrews and 2 assembly screws
Note: Backshell can be provided with custom logo, consult Molex

Features and Benefits

- Eliminates need for overmolding
- Can be used for both offset and straight cable exit applications
- No secondary operations needed to strain relieve
- Reduces overall labor, eliminates pre-shot, copper wrap, solder and final overmold assembly processes
- Assembly compatible with 4 port PCI bracket applications

Reference Information

Termination Specification Procedure: SD-73796-007

Assembled With: 71425

Designed In: Millimeters

Physical

Housing: Zinc

Plating: Nickel or black non-conductive coating

www.molex.com/product/vhdc.html

0.80mm (.031") Pitch HandyLink™ Receptacle

44828

SMT, Right Angle

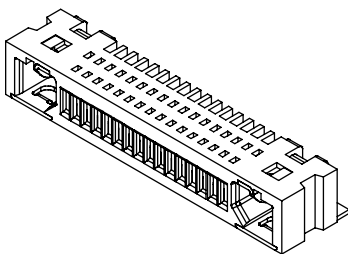

Features and Benefits

- Data rates compatible with USB 2.0 and IEEE 1394-1995 speeds, rated to 622 Mbs
- Rugged durability rated to 20,000 mating cycles
- Available in 2 to 16 circuit configurations, voided pinouts available to suit various applications
- Polarization feature and passive latching mechanism ensures proper mating with plug, cradle and cable
- Robust, insert molded sealed design supports IP54 protection requirements
- SMT leads allow population to both sides of PCB

Reference Information

Product Specification: PS-44828-001

Packaging: Embossed tape

UL File No.: E29179

CSA File No.: LR19980

TUV File No.: Pending

Mates With: 45593, 45339, 45560 and 36697

Designed In: Millimeters

Electrical

Voltage: 30V

Current: 1.5A (up to 3.0 depending on circuit configuration)

Contact Resistance: 50 milliohms max.

Dielectric Withstanding Voltage: 5 mA max.

Insulation Resistance: 1000 Megohms min.

Mechanical

Contact Insertion Force: 0.5N min.

Contact Retention to Housing: 2.5N min.

Mating Force: 20N (4.5 lbf)

Unmating Force: 40N (8.99 lbf)

Normal Force: 0.5N min.

Durability: 20,000 cycles

Physical

Housing: Black LCP, UL 94V-0

Contact: Copper Alloy

Plating: Contact Area—Gold over Palladium Nickel

Solder Tail Area—Tin

| Order No. | No. of Positions Loaded | Voided Pins | Lead-free |
|----------------------------|-------------------------|-------------|-----------|
| 44828-1162 | 16 | None | Yes |
| 44828-1163 | 15 | 15 | |

0.80mm (.031") Pitch HandyLink™ Plug

45339

Wire-terminated Cable Plug

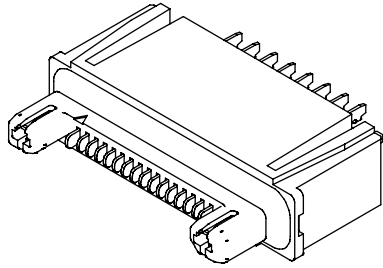

Features and benefits

- Data rates compatible with USB 2.0 and IEEE 1394-1995 speeds, rated to 622 Mbs
- Rugged durability rated to 20,000 mating cycles
- Available in 2 to 16 circuit configurations, voided pinouts available to suit various applications
- Polarization feature and passive latching mechanism ensures proper mating with receptacle
- First-mate/last-break pins 1 and 16 provide grounding protection during hot plugging. Other FMLB positions available upon request
- Standard and custom cable assemblies available, 36697 series

Reference Information

Product Specification: PS-44828-001
Packaging: Tray
UL File No.: E29179
CSA File No.: LR19980
TUV File No.: Pending
Mates With: 44828 receptacle
Designed In: Millimeters

Electrical

Voltage: 30V
Current: 1.5A (up to 3.0 depending on circuit configuration)
Contact Resistance: 50 milliohms max.
Dielectric Withstanding Voltage: 300V
Insulation Resistance: 1000 Megohms min.

Mechanical

Contact Insertion Force: 0.5N min.
Contact Retention to Housing: 2.5N min.
Mating Force: 20N (4.5 lbf)
Unmating Force: 40N (8.99 lbf)
Normal Force: 0.5N min.
Durability: 20,000 cycles

Physical

Housing: Black LCP, UL 94V-0
Contact: Copper Alloy
Plating: Contact Area—Gold over Palladium Nickel
Solder Tail Area—Tin
Wire Range: 22-34 AWG

| Order No. | No. of Positions Loaded | Voided Pins | Lead-free |
|----------------------------|-------------------------|--------------------|-----------|
| 45339-1600 | 16 | None | Yes |
| 45339-1601 | 2 | 2 to 15 | |
| 45339-1602 | 8 | 2 to 8 and 15 | |
| 45339-1603 | 9 | 2 to 7 and 15 | |
| 45339-1604 | 10 | 7,10,11,14,15,16 | |
| 45339-1605 | 15 | 15 | |
| 45339-1606 | 14 | 7, 8 | |
| 45339-1607 | 5 | 1 to 3 and 8 to 15 | |

0.80mm (.031") Pitch HandyLink™ PCB Plug

45593

Through Hole, Vertical

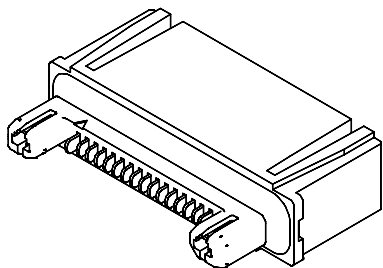

Features and Benefits

- Data rates compatible with USB 2.0 and IEEE 1394-1995 speeds, rated to 622 Mbs
- Rugged durability rated to 20,000 mating cycles
- Available in 2 to 16 circuit configurations, voided pinouts available to suit various applications
- Polarization feature and passive latching mechanism ensure proper mating with receptacle
- First mate, last break pins 1 and 16 provide grounding protection during hot plugging. Other FMLB positions available upon request
- Additional solder tail lengths available upon request

Reference Information

Product Specification: PS-44828-001
Packaging: Tray
UL File No.: E29179
CSA File No.: LR19980
TUV File No.: Pending
Mates With: 44828 receptacle
Designed In: Millimeters

Electrical

Voltage: 30V
Current: 1.5A (up to 3.0 depending on circuit configuration)
Contact Resistance: 50 milliohms max.
Dielectric Withstanding Voltage: 300V
Insulation Resistance: 1000 Megohms min.

Mechanical

Contact Insertion Force: 0.5N min.
Contact Retention to Housing: 2.5N min.
Mating Force: 20N (4.5 lbf)
Unmating Force: 40N (8.99 lbf)
Normal Force: 0.5N min.
Durability: 20,000 cycles

Physical

Housing: Black LCP, UL 94V-0
Contact: Copper Alloy
Plating: Contact Area—Gold over palladium Nickel
Solder Tail Area—Tin

| Order No. | No. of Positions Loaded | Voided Pins | Lead-free |
|----------------------------|-------------------------|--------------------|-----------|
| 45593-1600 | 16 | None | Yes |
| 45593-1601 | 2 | 2 to 15 | |
| 45593-1602 | 8 | 2 to 8 and 15 | |
| 45593-1603 | 9 | 7,8,10,11,14,15 | |
| 45593-1604 | 10 | 7,10,11,14,15,16 | |
| 45593-1605 | 15 | 15 | |
| 45593-1606 | 14 | 7, 8 | |
| 45593-1607 | 5 | 1 to 3 and 8 to 15 | |

0.80mm (.031") Pitch HandyLink™ Cradle Connector

45560

**SMT, Perpendicular and
Parallel Versions**

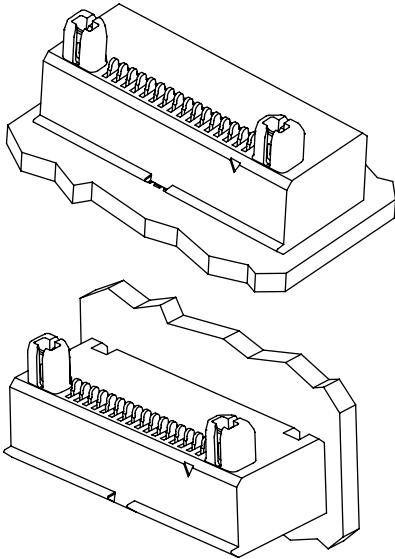

| Order No. | Description | No. of Positions Loaded | Lead-free |
|----------------------------|---------------------------------|-------------------------|-----------|
| 45560-0160 | Perpendicular to PCB (vertical) | 16 | Yes |
| 45560-0161 | Parallel to PCB (right angle) | | |

Features and Benefits

- Data rates compatible with USB 2.0 and IEEE 1394-1995 speeds, rated to 622 Mbs
- Rugged durability rated to 15,000 mating cycles
- Available in 2 to 16 circuit configurations, voided pinouts available to suit various applications
- Polarization feature and passive latching mechanism ensures proper mating with receptacle
- Robust design offered in both perpendicular and parallel mounting to the PCB for design flexibility in docking applications
- Optional screw mount hold down to PCB provides additional mechanical stability to PCB

Reference Information

Product Specification: PS-44828-001
 Packaging: Embossed tape
 UL File No.: E29179
 CSA File No.: LR19980
 TUV File No.: Pending
 Mates With: 44828 receptacle
 Designed In: Millimeters

Electrical

Voltage: 30V
 Current: 1.5A (up to 3.0 depending on circuit configuration)
 Contact Resistance: 50 milliohms max.
 Dielectric Withstanding Voltage: 300V
 Insulation Resistance: 1000 Megohms min.

Mechanical

Contact Insertion Force: 0.5N min.
 Contact Retention to Housing: 2.5N min.
 Mating Force: 20N (4.5 lbf)
 Unmating Force: 40N (8.99 lbf)
 Normal Force: 0.5N min.
 Durability: 15,000 cycles

Physical

Housing: Black LCP, UL 94V-0
 Contact: Copper Alloy
 Plating: Contact Area—Gold over Palladium Nickel
 Solder Tail Area—Tin

0.80mm (.031") Pitch HandyLink™ Cable Assembly

36697

**HandyLink to HandyLink
With Straight Overmolds**

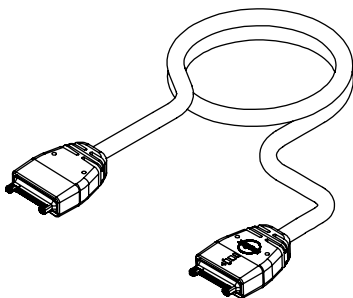

Features and Benefits

- Data rates compatible with USB 2.0 and 1394-1995 speeds, rated to 622Mbs
- Rugged durability rated to 20,000 mating cycles
- Polarization feature and passive latching mechanism ensures proper mating with receptacle
- First-mate/last-break pins 1 and 16 provide grounding protection during hot plugging
- Customizable pinouts and personalized logo area available to suit various applications
- Low profile height and compact width provide the perfect solution for small pluggable hand held devices
- Various cable lengths available for design flexibility

Reference Information

Product Specification: PS-36697-001
 Packaging: Bag
 Mates With: 44828 receptacle
 Designed In: Millimeters

Electrical

Voltage: 30V
 Current: 1.5A (up to 3.0 depending on circuit configuration)
 Contact Resistance: 50 milliohms max.
 Dielectric Withstanding Voltage: 300V
 Insulation Resistance: 1000 Megohms min.

Mechanical

Mating Force: 20N (4.5 lbf)
 Unmating Force: 40N (8.99 lbf)
 Durability: 20,000 cycles

Physical

Color: Black
 Cable Type: PVC
 Contact: Copper Alloy
 Plating: Contact Area—Gold over Palladium Nickel

| Circuits | Cable Length | Order No. | Wire Gauge | Lead-free |
|----------|----------------|----------------------------|------------|-----------|
| 16 | 1.0m (3.28 ft) | 36697-0001 | 30 AWG | Yes |
| | 2.0m (6.56 ft) | 36697-0002 | | |
| | 3.0m (9.84 ft) | 36697-0003 | | |

0.80mm (.031") Pitch HandyLink™ Cable Assembly

36697

HandyLink to HandyLink With Right Angle Overmolds

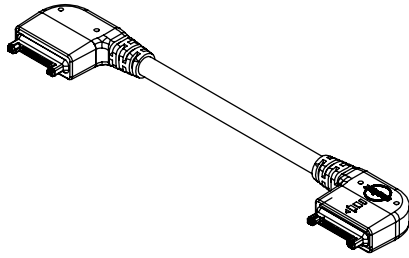

Features and Benefits

- Data rates compatible with USB 2.0 and 1394-1995 speeds, rated to 622Mbs
- Rugged durability rated to 20,000 mating cycles
- Polarization feature and passive latching mechanism ensures proper mating with receptacle
- First-mate/last-break pins 1 and 16 provide grounding protection during hot plugging
- Customizable pinouts and personalized logo area available to suit various applications
- Low profile height and compact width provide the perfect solution for small pluggable hand held devices
- Various cable lengths available for design flexibility

Reference Information

Product Specification: PS-36697-001
Packaging: Bag
Mates With: 44828 Receptacle
Designed In: Millimeters

Electrical

Voltage: 30V
Current: 1.5A (up to 3.0 depending on circuit configuration)
Contact Resistance: 50 milliohms max.
Dielectric Withstanding Voltage: 300V
Insulation Resistance: 1000 Megohms min.

Mechanical

Mating Force: 20N (4.5 lbf)
Unmating Force: 40N (8.99 lbf)
Durability: 20,000 cycles

Physical

Color: Black
Cable Type: PVC
Contact: Copper Alloy
Plating: Contact Area—Gold over Palladium Nickel

| Circuits | Cable Length | Order No. | Wire Gauge | Lead-free |
|----------|----------------|----------------------------|------------|-----------|
| 16 | 1.0m (3.28 ft) | 36697-0010 | 30 AWG | Yes |
| | 2.0m (6.56 ft) | 36697-0011 | | |
| | 3.0m (9.84 ft) | 36697-0012 | | |

0.80mm (.031") Pitch HandyLink™ Cable Assembly

36697

HandyLink Straight Overmold to USB "A" Plug

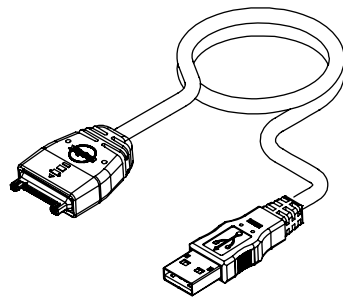

Features and Benefits

- Data rates compatible with USB 2.0 and IEEE 1394-1995 speeds, rated to 622 Mbs
- Rugged durability rated to 20,000 mating cycles
- Polarization feature and passive latching mechanism ensures proper mating with receptacle
- First-mate/last-break pins 1 and 16 provide grounding protection during hot plugging
- Customizable pinouts and personalized logo area available to suit various applications
- Low profile height and compact width provide the perfect solution for small pluggable hand held devices
- Various cable lengths available for design flexibility

Reference Information

Product Specification: PS-36697-001
Packaging: Bag
Mates With: 44828
Designed In: Millimeters

Electrical

Voltage: 30V
Current: 1.5A (up to 3.0 depending on circuit configuration)
Contact Resistance: 50 milliohms max.
Dielectric Withstanding Voltage: 300V
Insulation Resistance: 1000 Megohms min.

Mechanical

Mating Force: 20N (4.5 lbf)
Unmating Force: 40N (8.99 lbf)
Durability: 20,000 cycles

Physical

Color: Black
Cable Type: PVC
Contact: Copper Alloy
Plating: Contact Area—Gold over Palladium Nickel

| Circuits | Cable Length | Order No. | Wire Gauge | Lead-free |
|------------------|----------------|----------------------------|---------------|-----------|
| 4, plus 1 ground | 1.0m (3.28 ft) | 36697-0021 | 26 and 28 AWG | Yes |
| | 2.0m (6.56 ft) | 36697-0022 | | |
| | 3.0m (9.84 ft) | 36697-0023 | | |

0.80mm (.031") Pitch HandyLink™ Cable Assembly

36697

HandyLink Right Angle Overmold to USB "A" Plug

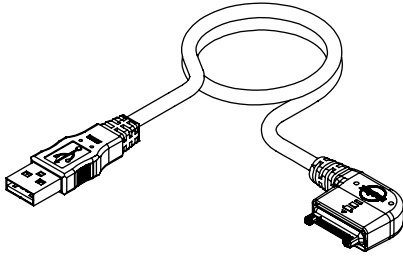

Features and Benefits

- Data rates compatible with USB 2.0 and IEEE 1394-1995 speeds, rated to 622 Mbs
- Rugged durability rated to 20,000 mating cycles
- Polarization feature and passive latching mechanism ensures proper mating with receptacle
- First-mate/last-break pins 1 and 16 provide grounding protection during hot plugging
- Customizable pinouts and personalized logo area available to suit various applications
- Low profile height and compact width provide the perfect solution for small pluggable hand held devices
- Various cable lengths available for design flexibility

Reference Information

Product Specification: PS-36697-001
Packaging: Bag
Mates With: 44828
Designed In: Millimeters

Electrical

Voltage: 30V
Current: 1.5A (up to 3.0 depending on circuit configuration)
Contact Resistance: 50 milliohms max.
Dielectric Withstanding Voltage: 300V
Insulation Resistance: 1000 Megohms min.

Mechanical

Mating Force: 20N (4.5 lbf)
Unmating Force: 40N (8.99 lbf)
Durability: 20,000 cycles

Physical

Color: Black
Cable Type: PVC
Contact: Copper Alloy
Plating: Contact Area—Gold over Palladium Nickel

| Circuits | Cable Length | Order No. | Wire Gauge | Lead-free |
|------------------|----------------|----------------------------|---------------|-----------|
| 4, plus 1 ground | 1.0m (3.28 ft) | 36697-0061 | 26 and 28 AWG | Yes |
| | 2.0m (6.56 ft) | 36697-0062 | | |
| | 3.0m (9.84 ft) | 36697-0063 | | |

0.80mm (.031") Pitch HandyLink™ Cable Assembly

36697

HandyLink Straight Overmold to USB "A" Receptacle

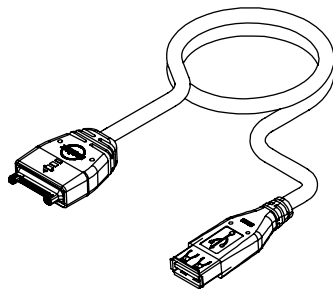

Features and Benefits

- Data rates compatible with USB 2.0 and IEEE 1394-1995 speeds, rated to 622 Mbs
- Rugged durability rated to 20,000 mating cycles
- Polarization feature and passive latching mechanism ensures proper mating with receptacle
- First-mate/last-break pins 1 and 16 provide grounding protection during hot plugging
- Customizable pinouts and personalized logo area available to suit various applications
- Low profile height and compact width provide the perfect solution for small pluggable hand held devices
- Various cable lengths available for design flexibility

Reference Information

Product Specification: PS-36697-001
Packaging: Bag
Mates With: 44828
Designed In: Millimeters

Electrical

Voltage: 30V
Current: 1.5A (up to 3.0 depending on circuit configuration)
Contact Resistance: 50 milliohms max.
Dielectric Withstanding Voltage: 300V
Insulation Resistance: 1000 Megohms min.

Mechanical

Mating Force: 20N (4.5 lbf)
Unmating Force: 40N (8.99 lbf)
Durability: 20,000 cycles

Physical

Color: Black
Cable Type: PVC
Contact: Copper Alloy
Plating: Contact Area—Gold over Palladium Nickel

| Circuits | Cable Length | Order No. | Wire Gauge | Lead-free |
|------------------|-----------------|----------------------------|---------------|-----------|
| 4, plus 1 ground | 1.0m (3.28 ft) | 36697-0090 | 26 and 28 AWG | Yes |
| | 2.0m (6.56 ft) | 36697-0091 | | |
| | 3.0m (9.84 ft) | 36697-0092 | | |
| | 2.05m (.672 ft) | 36697-0093 | | |

0.80mm (.031") Pitch HandyLink™ Cable Assembly

36697

**HandyLink Straight Overmold
to DB9**

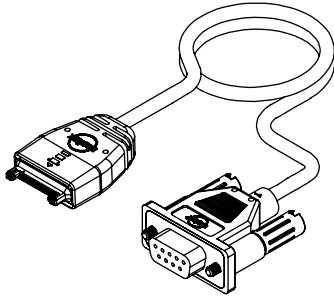

Features and Benefits

- Data rates compatible with USB 2.0 and IEEE 1394-1995 speeds, rated to 622 Mbs
- Rugged durability rated to 20,000 mating cycles
- Polarization feature and passive latching mechanism ensures proper mating with receptacle
- First-mate/last-break pins 1 and 16 provide grounding protection during hot plugging
- Customizable pinouts and personalized logo area available to suit various applications
- Low profile height and compact width provide the perfect solution for small pluggable hand held devices
- Various cable lengths available for design flexibility

Reference Information

Product Specification: PS-36697-001
Packaging: Bag
Mates With: 44828
Designed In: Millimeters

Electrical

Voltage: 30V
Current: 1.5A (up to 3.0 depending on circuit configuration)
Contact Resistance: 50 milliohms max.
Dielectric Withstanding Voltage: 300V
Insulation Resistance: 1000 Megohms min.

Mechanical

Mating Force: 20N (4.5 lbf)
Unmating Force: 40N (8.99 lbf)
Durability: 20,000 cycles

Physical

Color: Black
Cable Type: PVC
Contact: Copper Alloy
Plating: Contact Area—Gold over Palladium Nickel

| Circuits | Cable Length | Order No. | Wire Gauge | Lead-free |
|----------|----------------|----------------------------|------------|-----------|
| 9 | 1.0m (3.28 ft) | 36697-0041 | 24 AWG | Yes |
| | 2.0m (6.56 ft) | 36697-0042 | | |
| | 3.0m (9.84 ft) | 36697-0043 | | |

0.80mm (.031") Pitch HandyLink™ Cable Assembly

36697

**HandyLink Straight Overmold
to Pigtail**

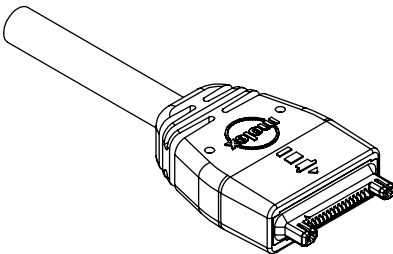

Features and Benefits

- Data rates compatible with USB 2.0 and IEEE 1394-1995 speeds, rated to 622 Mbs
- Rugged durability rated to 20,000 mating cycles
- Polarization feature and passive latching mechanism ensures proper mating with receptacle
- First-mate/last-break pins 1 and 16 provide grounding protection during hot plugging
- Customizable pinouts and personalized logo area available to suit various applications
- Low profile height and compact width provide the perfect solution for small pluggable hand held devices
- Various cable lengths available for design flexibility

Reference Information

Product Specification: PS-36697-001
Packaging: Bag
Mates With: 44828
Designed In: Millimeters

Electrical

Voltage: 30V
Current: 1.5A (up to 3.0 depending on circuit configuration)
Contact Resistance: 50 milliohms max.
Dielectric Withstanding Voltage: 300V
Insulation Resistance: 1000 Megohms min.

Mechanical

Mating Force: 20N (4.5 lbf)
Unmating Force: 40N (8.99 lbf)
Durability: 20,000 cycles

Physical

Color: Black
Cable Type: PVC
Contact: Copper Alloy
Plating: Contact Area—Gold over Palladium Nickel

| Circuits | Cable Length | Order No. | Wire Gauge | Lead-free |
|----------|----------------|----------------------------|------------|-----------|
| 16 | 1.0m (3.28 ft) | 36697-0031 | 30 AWG | Yes |
| | 2.0m (6.56 ft) | 36697-0032 | | |
| | 3.0m (9.84 ft) | 36697-0033 | | |

LFH™ Matrix 50 and 75 Connector Systems

The Low Force Helix (LFH) contact was designed for high-pin-count signal applications where there is a need for reliability and performance. Designed for both cable I/O and board-to-board applications, the system's low insertion forces make it ideal for situations where multiple signal lines need to be terminated or packaged in a limited space. The patented "helix" plug pin interfaces with a split-beam receptacle contact giving a low insertion force with 2-point contact reliability.

Circuit sizes range from 60 to 200 circuits in the Matrix 50 system and 96 to 130 circuits in the Matrix 75 system. Matrix 50 features I/O shielding exclusively, while Matrix 75 offers shielded and unshielded versions. Both systems support vertical and right angle board mounting.

Features and Benefits

- Low insertion forces of 42g per contact
- Redundant contact points for long-term reliability
- Normal forces of 75g per beam
- Contact (Hertz) forces averaging 225K psi
- High cycle life via controlled plating and contact surfaces
- Good electrical performance for high-speed applications
- Blind mate options available
- Docking hardware available for I/O systems
- SMT-compatible materials
- Cable assemblies available through Molex
- Termination of high-performance wire—26 to 36 AWG (depending upon application)
- Solder and weld terminations
- M3 and 4-40 hardware
- I/O system is D-sub size for standard panel cutouts, overmolds and hardware use (60 and 96 circuits)
- 30µ" min. Gold/50µ" min. Nickel plating
- Matrix 50 contact layout is on .050 x .050" spacing.
- Matrix 75 layout is on .075 x .075" spacing.

Mechanical

Please refer to individual product pages for details

Materials

Please refer to individual product pages for details

Environmental/Durability

After Temperature Cycling: <10 milliohms ΔR

After Cycle Humidity: <10 milliohms ΔR

After Flowing Mixed Gas Test: <10 milliohms ΔR

After 5000 Mated Cycles Durability: <10 milliohms ΔR

Please refer to individual product pages for more details

Electrical Characteristics—Matrix 50

Measured at 200 ps rise time for differential signals

Nominal Bandwidth: 3 to 4 GHz

Impedance: 80 to 104 ohms

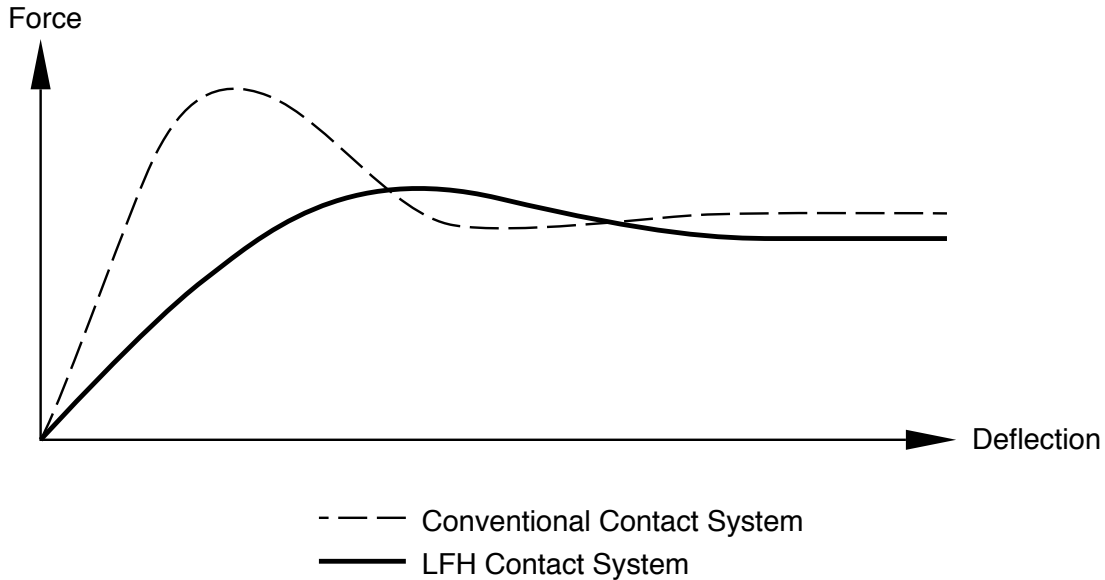

The LFH system's low insertion forces promote high cycle life and extended contact reliability. Compared with conventional contact systems, the patented "helix" LFH interface has a lower initial insertion force with a more gradual ramp up to the full normal force of 75g per beam.

LFH™ Matrix 50 and 75 Typical Applications

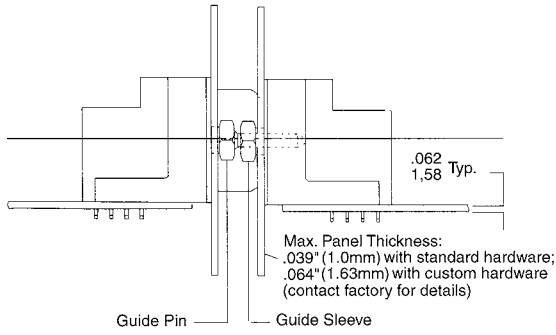

Matrix 50 I/O

Blind Mate Docking
Right Angle Plug to Right Angle Receptacle
60 and 160 Circuit

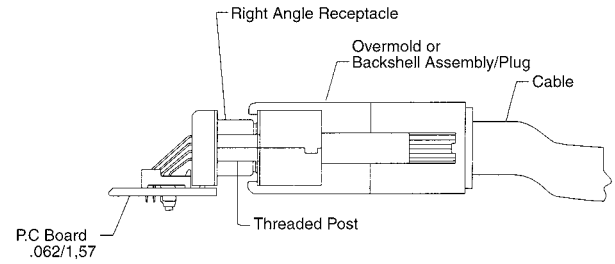

Matrix 50 I/O

Right Angle Receptacle to Cable Plug
60, 160 and 200 Circuit

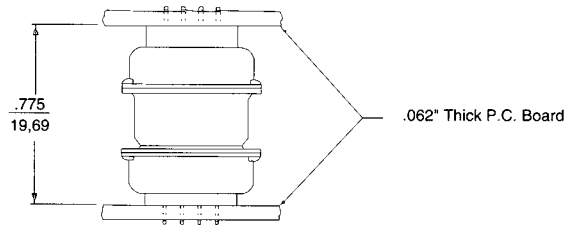

Matrix 75 I/O

Vertical Stacking
96 and 130 Circuit

1.27mm (.050") Pitch LFH™ Matrix 50 Shielded Receptacle

70928

60 Circuit, Right Angle

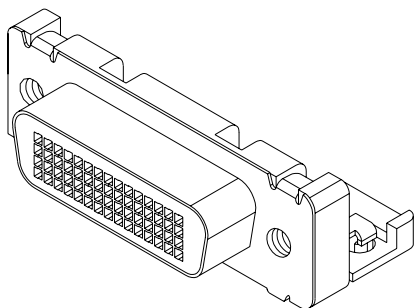

Features and Benefits

- High-performance, Low Force Helix terminal with contact layout .050 by .050"
- High cycle life from controlled plating and contact surfaces
- Suitable for high-density and high-performance applications
- Same size as 15-pin D-sub for standard panel cut-outs and hardware use
- M3 threaded inserts for attaching various hardware options
- Docking hardware 71628 and 71629
- Jackposts 70982
- Surface Mount Compatible

Reference Information

Product Specification: PS-70928
Packaging: Tube
UL File No.: E29179
CSA File No.: LR19980
Mates With: 70929
Designed In: Inches

Electrical

Voltage: 40V
Current: 1.0A
Contact Resistance: 20 milliohms max.
Dielectric Withstanding Voltage: 500V
Insulation Resistance: 100 Megohms min.

Mechanical

Contact Insertion Force: 60g max.
Mating Force: 50g nom.
Unmating Force: 20g min.
Durability: 5000 cycles

Physical

Housing: Glass-filled polymer, UL 94V-0
Contact: Beryllium Copper Alloy
Plating: Terminals—30µ" min. Gold over Nickel in contact area, 100µ" min. Tin over Nickel in PC tail area
Shields—150µ" min. bright Tin over Nickel all over Copper flash

| Circuits | Order No. | PC Tail Length | Lead-free |
|----------|----------------------------|----------------|-----------|
| 60 | 70928-2000 | 2.01 (.079) | Yes |
| | 70928-2001 | 2.34 (.092) | |
| | 70928-2002 | 2.64 (.104) | |
| | 70928-2005 | 2.01 (.079) | |
| | 70928-2007 | 3.18 (.125) | |

1.27mm (.050") Pitch LFH™ Matrix 50 Shielded Receptacle

70928

60 Circuit, Vertical

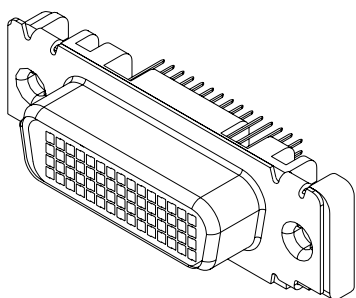

Features and Benefits

- High-performance, Low Force Helix terminal with contact layout .050 by .050"
- High cycle life from controlled plating and contact surfaces
- Suitable for high-density and high-performance applications
- Same size as 15-pin D-sub for standard panel cut-outs and hardware use
- M3 threaded inserts for attaching various hardware options
- Docking hardware 71628 and 71629
- Jackposts 70982
- Surface Mount Compatible

Reference Information

Product Specification: PS-70928
Packaging: Tube
UL File No.: E29179
CSA File No.: LR19980
Mates With: 70929
Designed In: Inches

Electrical

Voltage: 40V
Current: 1.0A
Contact Resistance: 20 milliohms max.
Dielectric Withstanding Voltage: 500V
Insulation Resistance: 100 Megohms min.

Mechanical

Contact Insertion Force: 60g max.
Mating Force: 50g nom.
Unmating Force: 20g min.
Durability: 5000 cycles

Physical

Housing: Glass-filled polymer, UL 94V-0
Contact: Beryllium Copper Alloy
Plating: Terminals—30µ" min. Gold over Nickel in contact area, 100µ" min. Tin over Nickel in PC tail area
Shields—150µ" min. bright Tin over Nickel all over Copper flash

| Circuits | Order No. | PC Tail Length | Lead-free |
|----------|----------------------------|----------------|-----------|
| 60 | 70928-0002 | 2.34 (.092) | Yes |

1.27mm (.050") Pitch LFH™ Matrix 50 Shielded Plug

70929

60 Circuit, Right Angle

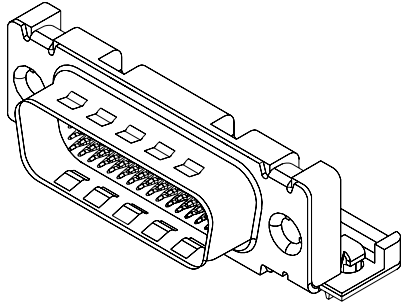

Features and Benefits

- High-performance, Low Force Helix terminal with contact layout .050 by .050"
- High cycle life from controlled plating and contact surfaces
- Suitable for high-density and high-performance applications
- Same size as 15-pin D-sub for standard panel cut-outs and hardware use
- M3 threaded inserts for attaching various hardware options
- Docking hardware 71628 and 71629
- Jackposts 70982
- Surface Mount Compatible

Reference Information

Product Specification: PS-70928
Packaging: Tube
UL File No.: E29179
CSA File No.: LR19980
Mates With: 70928
Designed In: Inches

Electrical

Voltage: 40V
Current: 1.0A
Contact Resistance: 20 milliohms max.
Dielectric Withstanding Voltage: 500V
Insulation Resistance: 100 Megohms min.

Mechanical

Contact Insertion Force: 60g max.
Mating Force: 50g nom.
Unmating Force: 20g min.
Durability: 5000 cycles

Physical

Housing: Glass-filled polymer, UL 94V-0
Contact: Phosphor Bronze Alloy
Plating: Terminals—30µ" min. Gold over Nickel in contact area, 100µ" min. Tin over Nickel in PC tail area
Shields—150µ" min. bright Tin over Nickel all over Copper flash

| Circuits | Order No. | PC Tail Length | Lead-free |
|----------|----------------------------|----------------|-----------|
| 60 | 15-92-2250 | 2.34 (.092) | Yes |
| | 15-92-2253 | 2.64 (.104) | |

1.27mm (.050") Pitch LFH™ Matrix 50 Shielded Plug

70929

60 Circuit, Vertical

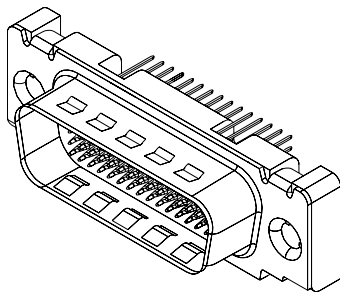

Features and Benefits

- High-performance, Low Force Helix terminal with contact layout .050 by .050"
- High cycle life from controlled plating and contact surfaces
- Suitable for high-density and high-performance applications
- Same size as 15-pin D-sub for standard panel cut-outs and hardware use
- M3 threaded inserts for attaching various hardware options
- Docking hardware 71628 and 71629
- Jackposts 70982
- Surface Mount Compatible

Reference Information

Product Specification: PS-70928
Packaging: Tube
UL File No.: E29179
CSA File No.: LR19980
Mates With: 70928
Designed In: Inches

Electrical

Voltage: 40V
Current: 1.0A
Contact Resistance: 20 milliohms max.
Dielectric Withstanding Voltage: 500V
Insulation Resistance: 100 Megohms min.

Mechanical

Contact Insertion Force: 60g max.
Mating Force: 50g nom.
Unmating Force: 20g min.
Durability: 5000 cycles

Physical

Housing: Glass-filled polymer, UL 94V-0
Contact: Phosphor Bronze Alloy
Plating: Terminals—30µ" min. Gold over Nickel in contact area, 100µ" min. Tin over Nickel in PC tail area
Shields—150µ" min. bright Tin over Nickel all over Copper flash

| Circuits | Order No. | PC Tail Length | Lead-free |
|----------|----------------------------|----------------|-----------|
| 60 | 15-92-2251 | 2.34 (.092) | Yes |

1.27mm (.050") Pitch LFH™ Matrix 50 Plug Cable Kit

70929/70984

Subassembly and Terminal Sticks 60 Circuit

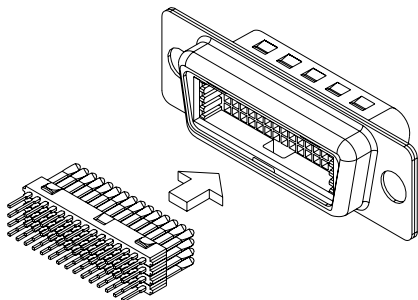

Features and Benefits

- Cable assemblies available through Molex-approved suppliers
- Termination of a variety of wire types 28 to 36 AWG (depending on application)
- Wire terminated by direct weld or solder
- 4 terminal sticks required per subassembly (terminal sticks sold separately)
- Same size as 15-pin D-sub for standard overmolding and back shell hardware

Reference Information

Product Specification: PS-70928
Application Specification: PS-70929
Termination Specification: ES-70929
Packaging: Box and tray
UL File No.: E29179 CSA File No.: LR19980
Mates With: 70928
Designed In: Inches

Electrical

Voltage: 40V
Current: 1.0A
Contact Resistance: 20 milliohms max.
Dielectric Withstanding Voltage: 500V
Insulation Resistance: 100 Megohms min.

Mechanical

Contact Insertion Force: 60g max.
Mating Force: 50g nom.
Unmating Force: 20g min.
Durability: 5000 cycles

Physical

Housing: Glass-filled polymer, UL 94V-0
Contact: Plugs—Phosphor Bronze Alloy
Receptacle—Beryllium Copper Alloy
Plating: Terminals—30µ" min. Gold over Nickel in contact area, 100µ" min. Tin/Lead over Nickel in PC tail area
Shields—150µ" min. bright Tin over Nickel all over Copper flash

| Subassembly | | |
|-------------|---|-----------|
| Order No. | Description | Lead-free |
| 70929-2000* | 60-Circuit I/O Plug Connector Subassembly | Yes |

| Terminal Sticks—4 Sticks Required per Subassembly | | | |
|---|-----------------------------------|-------------|-----------|
| Order No. | Description | Trim Length | Lead-free |
| 51-24-2021 | With Carrier | N/A | Yes |
| 51-24-2022 | Trimmed to Length without Carrier | 3.30 (.130) | |
| 70984-1007†‡ | With Busbar and Carrier | N/A | |
| 70984-1010‡ | | | |

* Stick Loading Tool 62200-1500 can be used for inserting sticks into subassembly

† Sticks can be trimmed using LFH Stick Preparation Tool Kit 62200-1100

‡ 50µ" Nickel plating on tail area

1.27mm (.050") Pitch LFH™ Matrix 50 Receptacle Cable Kit

71691/70985

Subassembly and Terminal Sticks 60 Circuit

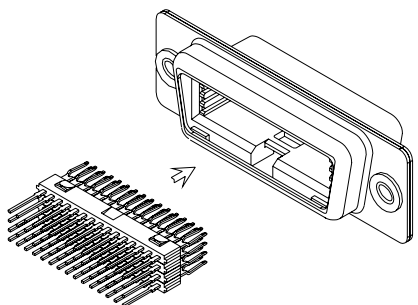

Features and Benefits

- Cable assemblies available from Molex
- Termination of a variety of wire types 28 to 36 AWG (depending on application)
- Wire terminated by direct weld or solder
- 4 terminal sticks required per subassembly (terminal sticks sold separately)
- Same size as 15-pin D-sub for standard overmolding and back shell hardware

Reference Information

Product Specification: PS-70928
Application Specification: PS-71691
Termination Specification: ES-70929
Packaging: Box and tray
UL File No.: E29179
CSA File No.: LR19980
Mates With: 70929
Designed In: Inches

Electrical

Voltage: 40V
Current: 1.0A
Contact Resistance: 20 milliohms max.
Dielectric Withstanding Voltage: 500V
Insulation Resistance: 100 Megohms min.

Mechanical

Contact Insertion Force: 60g max.
Mating Force: 50g nom.
Unmating Force: 20g min.
Durability: 5000 cycles

Physical

Housing: Glass-filled polymer, UL 94V-0
Contact: Receptacle—Beryllium Copper Alloy
Plating: Terminals—30µ" min. Gold over Nickel in contact area, 100µ" min. Tin over Nickel in PC tail area
Shields—100µ" min. bright Tin over Copper

| Subassembly | | |
|-------------|---|-----------|
| Order No. | Description | Lead-free |
| 71691-0003* | 60-Circuit I/O Receptacle Connector Subassembly | Yes |

* Stick Loading Tool 62200-1600 can be used for inserting sticks into subassembly

| Terminal Sticks—4 Sticks Required per Subassembly | | | |
|---|-----------------------------------|-------------|-----------|
| Order No. | Description | Trim Length | Lead-free |
| 51-25-2011 | With Carrier† | N/A | Yes |
| 51-25-2012 | Trimmed to Length without Carrier | 5.46 (.215) | |
| 51-25-2014 | | 3.30 (.130) | |

† Sticks can be trimmed using LFH Stick Preparation Tool Kit 62200-1100

1.27mm (.050") Pitch LFH™ Matrix 50 Hardware

71245 Overmold Can Kit

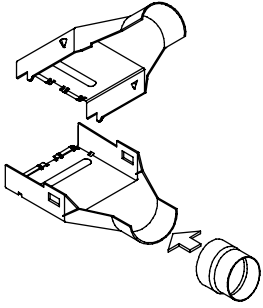

Features and Benefits

- Use with 60-circuit plug cable kit
- Each can kit includes top and bottom pieces
- Can pieces snap together to provide continuous electrical shielding with connector and cable
- Crimp ferrule 73772 sold separately

Reference Information

Application Specification: PS-70929

Packaging: Bag

Designed In: Inches

Physical

Plating: Bright Tin over Copper flash

| Overmold Can | | |
|----------------------------|--------------------|-----------|
| Order No. | Cable Sizes (max.) | Lead-free |
| 71245-2000 | 11.18 (.440) | Yes |
| 71245-3000 | 12.57 (.495) | |

1.27mm (.050") Pitch LFH™ Matrix 50 Shielded Receptacle

71626

160 Circuit, Right Angle

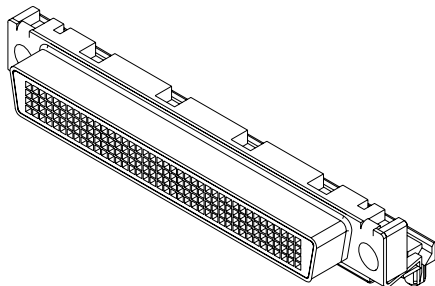

Features and Benefits

- High-performance, Low Force Helix terminal with contact layout .050 by .050"
- High cycle life from controlled plating and contact surfaces
- Suitable for high-density and high-performance applications
- M3 threaded insert for attaching various hardware options
- Docking hardware 71628 and 71629
- Jackposts 70982
- Surface Mount Compatible

Reference Information

Product Specification: PS-71626
Packaging: Tube
UL File No.: E29179
CSA File No.: LR19980
Mates With: 71624
Designed In: Inches

Electrical

Voltage: 40V
Current: 1.0A
Contact Resistance: 20 milliohms max.
Dielectric Withstanding Voltage: 500V
Insulation Resistance: 100 Megohms min.

Mechanical

Contact Insertion Force: 60g max.
Mating Force: 50g nom.
Unmating Force: 20g min.
Durability: 5000 cycles

Physical

Housing: Glass-filled polymer, UL 94V-0
Contact: Beryllium Copper Alloy
Plating: Terminals—30µ" min. Gold over Nickel in contact area, 100µ" min. Tin over Nickel in PC tail area
Shields—150µ" min. bright Tin over Nickel all over Copper flash

| Circuits | Order No. | PC Tail Length | Lead-free |
|----------|-----------------------------|----------------|-----------|
| 160 | 51-24-1040 | 2.34 (.092) | Yes |
| | 51-24-1041 | 2.01 (.079) | |
| | 71626-2002 | 3.18 (.125) | |
| | 71626-4000* | 2.34 (.092) | |

* Guide hardware attached (71629-4000)

1.27mm (.050") Pitch LFH™ Matrix 50 Shielded Receptacle

71626

160 Circuit, Vertical

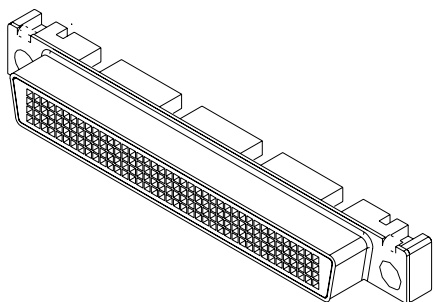

Features and Benefits

- High-performance, Low Force Helix terminal with contact layout .050 by .050"
- High cycle life from controlled plating and contact surfaces
- Suitable for high-density and high-performance applications
- M3 threaded insert with optional board lock for attaching various hardware options
- Docking hardware 71628 and 71629
- Jackposts 70982
- Surface Mount Compatible

Reference Information

Product Specification: PS-71626
Packaging: Tube
UL File No.: E29179
CSA File No.: LR19980
Mates With: 71624
Designed In: Inches

Electrical

Voltage: 40V
Current: 1.0A
Contact Resistance: 20 milliohms max.
Dielectric Withstanding Voltage: 500V
Insulation Resistance: 100 Megohms min.

Mechanical

Contact Insertion Force: 60g max.
Mating Force: 50g nom.
Unmating Force: 20g min.
Durability: 5000 cycles

Physical

Housing: Glass-filled polymer, UL 94V-0
Contact: Beryllium Copper Alloy
Plating: Terminals—30µ" min. Gold over Nickel in contact area, 100µ" min. Tin over Nickel in PC tail area
Shields—150µ" min. bright Tin over Nickel all over Copper flash

| Circuits | Order No. | Feature | PC Tail Length | Lead-free |
|----------|----------------------------|------------------------------------|----------------|-----------|
| 160 | 71626-1001 | M3 Threaded Insert with Board Lock | 2.34 (.092) | Yes |
| | 71626-1003 | M3 Threaded Insert | 3.18 (.125) | |
| | 71626-1004 | M3 Threaded Insert with Board Lock | | |
| | 71626-1006 | M3 Threaded Insert | 4.49 (.177) | |
| | 71626-1007 | | 5.33 (.210) | |
| | 51-24-1030 | | 2.34 (.092) | |

1.27mm (.050") Pitch LFH™ Matrix 50 Shielded Plug

71624

160 Circuit, Right Angle

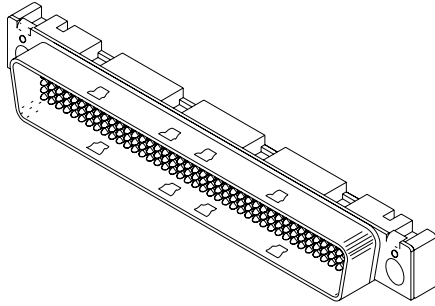

Features and Benefits

- High-performance, Low Force Helix terminal with contact layout .050 by .050"
- High cycle life from controlled plating and contact surfaces
- Suitable for high-density and high-performance applications
- Optional M3 threaded insert for attaching various hardware options
- Docking hardware 71628 and 71629
- Jackposts 70982
- Surface Mount Compatible

Reference Information

Product Specification: PS-71626
Packaging: Tube
UL File No.: E29179
CSA File No.: LR19980
Mates With: 71626
Designed In: Inches

Electrical

Voltage: 40V
Current: 1.0A
Contact Resistance: 20 milliohms max.
Dielectric Withstanding Voltage: 500V
Insulation Resistance: 100 Megohms min.

Mechanical

Contact Insertion Force: 60g max.
Mating Force: 50g nom.
Unmating Force: 20g min.
Durability: 5000 cycles

Physical

Housing: Glass-filled polymer, UL 94V-0
Contact: Phosphor Bronze Alloy
Plating: Terminals—30µ" min. Gold over Nickel in contact area, 100µ" min. Tin over Nickel in PC tail area
Shields—150µ" min. bright Tin over Nickel all over Copper flash

| Circuits | Order No. | Description | PC Tail Length | Lead-free |
|----------|----------------------------|----------------------------|----------------|-----------|
| 160 | 51-25-1040 | With M3 Threaded Insert | 2.34 (.092) | Yes |
| | 71624-2004 | Without M3 Threaded Insert | | |

I/O Products

1.27mm (.050") Pitch LFH™ Matrix 50 Shielded Plug

71624

160 Circuit, Vertical

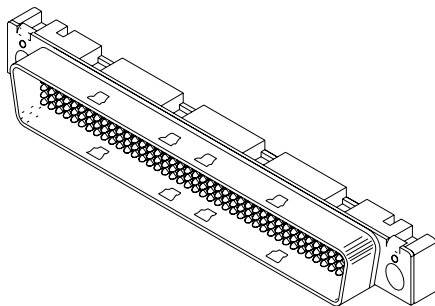

Features and Benefits

- High-performance, Low Force Helix terminal with contact layout .050 by .050"
- High cycle life from controlled plating and contact surfaces
- Suitable for high-density and high-performance applications
- M3 threaded insert with optional board lock for attaching various hardware options
- Docking hardware 71628 and 71629
- Jackposts 70982
- Surface Mount Compatible

Reference Information:

Product Specification: PS-71626
Packaging: Tube
UL File No.: E29179
CSA File No.: LR19980
Mates With: 71626
Designed In: Inches

Electrical

Voltage: 40V
Current: 1.0A
Contact Resistance: 20 milliohms max.
Dielectric Withstanding Voltage: 500V
Insulation Resistance: 100 Megohms min.

Mechanical

Contact Insertion Force: 60g max.
Mating Force: 50g nom.
Unmating Force: 20g min.
Durability: 5000 cycles

Physical

Housing: Glass-filled polymer, UL 94V-0
Contact: Phosphor Bronze Alloy
Plating: Terminals—30µ" min. Gold over Nickel in contact area, 100µ" min. Tin over Nickel in PC tail area
Shields—150µ" min. bright Tin over Nickel all over Copper flash

| Circuits | Order No. | Feature | PC Tail Length | Lead-free |
|----------|----------------------------|------------------------------------|----------------|-----------|
| 160 | 51-25-1030 | M3 Threaded Insert | 2.34 (.092) | Yes |
| | 71624-1001 | M3 Threaded Insert with Board Lock | | |
| | 71624-1003 | M3 Threaded Insert | 3.18 (.125) | |
| | 71624-1004 | M3 Threaded Insert with Board Lock | | |
| | 71624-1013 | M3 Threaded Insert | | |

1.27mm (.050") Pitch LFH™ Matrix 50 Plug Cable Kit

71624/70984

**Subassembly and Terminal Sticks
160 Circuit**

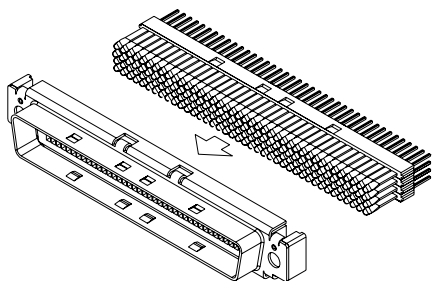

Features and Benefits

- Cable assemblies available from Molex
- Termination of a variety of wire types 28 to 36 AWG (depending on application)
- Wire terminated by direct weld or solder
- 4 terminal sticks required per subassembly (terminal sticks sold separately)

Reference Information

Product Specification: PS-71626
Application Specification: PS-71624
Termination Specification: ES-70929
Packaging: Box and tray
UL File No.: E29179
CSA File No.: LR19980
Mates With: 71626
Designed In: Inches

Electrical

Voltage: 40V
Current: 1.0A
Contact Resistance: 20 milliohms max.
Dielectric Withstanding Voltage: 500V
Insulation Resistance: 100 Megohms min.

Mechanical

Contact Insertion Force: 60g max.
Mating Force: 50g nom.
Unmating Force: 20g min.
Durability: 5000 cycles

Physical

Housing: Glass-filled polymer, UL 94V-0
Contact: Plugs—Phosphor Bronze Alloy
Plating: Terminals—30μ" min. Gold over Nickel in contact area, 100μ" min. Tin over Nickel in PC tail area
Shields—150μ" min. bright Tin over Nickel all over 50μ" Copper

| Subassembly | | |
|--|--|-----------|
| Order No. | Description | Lead-free |
| 71624-3000[†] | 160-Circuit I/O Plug Connector Subassembly | Yes |

[†] Stick Loading Tool 62200-1700 can be used for inserting sticks into subassembly

| Terminal Sticks—4 Sticks Required per Subassembly | | | |
|---|-----------------------------------|-------------|-----------|
| Order No. | Description | Trim Length | Lead-free |
| 51-25-1020 | With Carrier* | N/A | Yes |
| 70984-4009 | Trimmed to Length without Carrier | 3.30 (.130) | |

* Sticks can be trimmed using LFH Stick Preparation Tool Kit 62200-1100

1.27mm (.050") Pitch LFH™ Matrix 50 Shielded Receptacle

71718

200 Circuit, Right Angle

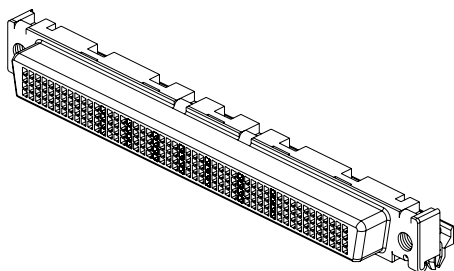

Features and Benefits

- High-performance, Low Force Helix terminal with contact layout .050 by .050"
- High cycle life from controlled plating and contact surfaces
- Suitable for high-density and high-performance applications
- M3 threaded inserts for attaching various hardware options
- Docking hardware 71628 and 71629
- Jackposts 70982
- Surface Mount Compatible

Reference Information

Product Specification: PS-71718
Packaging: Tube
UL File No.: E29179
CSA File No.: LR19980
Mates With: 71719
Designed In: Inches

Electrical

Voltage: 40V
Current: 1.0A
Contact Resistance: 20 milliohms max.
Dielectric Withstanding Voltage: 500V
Insulation Resistance: 100 Megohms min.

Mechanical

Contact Insertion Force: 60g max.
Mating Force: 50g nom.
Unmating Force: 20g min.
Durability: 5000 cycles

Physical

Housing: Glass-filled polymer, UL 94V-0
Contact: Beryllium Copper Alloy
Plating: Terminals—30μ" min. Gold over Nickel in contact area, 100μ" min. Tin over Nickel in PC tail area
Shields—150μ" min. bright Tin over Nickel all over Copper flash

| Circuits | Order No. | PC Tail Length | Lead-free |
|----------|----------------------------|----------------|-----------|
| 200 | 71718-2000 | 2.01 (.079) | Yes |
| | 71718-2001 | 3.05 (.120) | |

1.27mm (.050") Pitch LFH™ Matrix 50 I/O Plug Cable Kit

71719/71715

Subassembly and
Terminal Sticks
200 Circuit

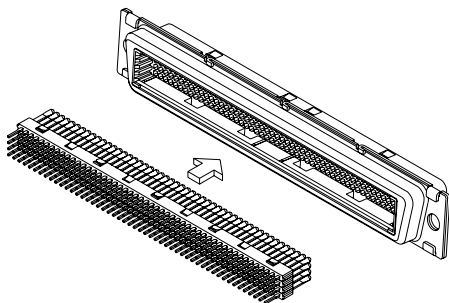

Features and Benefits

- Cable assemblies available from Molex
- Termination of a variety of wire types 28 to 36 AWG (depending on application)
- Wire terminated by direct weld or solder
- 4 terminal sticks required per subassembly (terminal sticks sold separately)

Reference Information

Product Specification: PS-71719-9999
Application Specification: AS-71719
Termination Specification: AS-71715
Packaging: Box and tray
UL File No.: E29179
CSA File No.: LR19980
Mates With: 71718
Designed In: Millimeters

Electrical

Voltage: 40V
Current: 1.0A max.
Contact Resistance: 20 milliohms max.
Dielectric Withstanding Voltage: 500V
Insulation Resistance: 100 Megohms min.

Mechanical

Contact Insertion Force: 60g max.
Mating Force: 50g nom.
Unmating Force: 20g min.
Durability: 5000 cycles

Physical

Housing: Glass-filled polymer. UL94V-0
Contact: Plugs—Phosphor Bronze Alloy
Plating: Terminals—30µ" min. Gold over Nickel in contact area, 100µ" min. Tin over Nickel in PC tail area
Shields—150µ" min. bright Tin over Nickel all over 50µ" Copper

| Subassembly | |
|-------------|---|
| Order No. | Description |
| 71719-3000 | 200 Circuit I/O Plug Connector Assembly |

| Subassembly | | |
|-------------|-----------------------------------|-------------|
| Order No. | Description | Trim Length |
| 71715-4001 | With Carrier | N/A |
| 71715-4002 | Trimmed to Length without Carrier | 3.30 (.130) |

1.90mm (.075") Pitch LFH™ Matrix 75 Shielded Receptacle

70660

96 Circuit
Right Angle

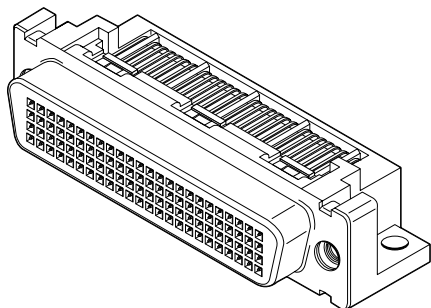

Features and Benefits

- High-performance, Low Force Helix terminal with contact layout .075 by .075"
- High cycle life from controlled plating and contact surfaces
- Suitable for high-density and high-performance applications
- 96-circuit same size as 50-pin standard D-sub for backshell hardware
- M3 threaded inserts for attaching various hardware options
- Docking hardware 71628 and 71629
- Jackposts 70982
- Surface Mount Compatible

Reference Information

Product Specification: PS-70660
Packaging: Tube
UL File No.: E291794
CSA File No.: LR19980
Mates With: 70665 or 71995
Designed In: Inches

Electrical

Voltage: 40V
Current: 1.0A
Contact Resistance: 20 milliohms max.
Dielectric Withstanding Voltage: 1000V
Insulation Resistance: 100 Megohms min.

Mechanical

Contact Insertion Force: 84g max.
Mating Force: 60g nom.
Unmating Force: 20g min.
Durability: 5000 cycles

Physical

Housing: Glass-filled polymer, UL 94V-0
Contact: Beryllium Copper Alloy
Plating: Terminals—30µ" min. Gold over Nickel in contact area, 100µ" min. Tin over Nickel in PC tail area
Shields—100µ" min. bright Tin over Copper

| Circuits | Order No. | PC Tail Length | Lead-free |
|----------|------------|----------------|-----------|
| 96 | 51-26-0000 | 2.34 (.092) | Yes |
| | 51-26-0003 | 3.43 (.135) | |

1.90mm (.075") Pitch LFH™ Matrix 75 Shielded Receptacle

70660
96 Circuit
Vertical

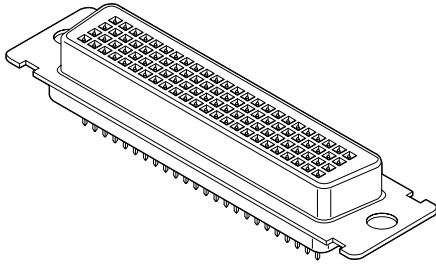

Features and Benefits

- High-performance, Low Force Helix terminal with contact layout .075 by .075"
- High cycle life from controlled plating and contact surfaces
- Suitable for high-density and high-performance applications
- 96-circuit same size as 50-pin standard D-sub for backshell hardware
- Surface Mount Compatible

Reference Information

Product Specification: PS-70660
Packaging: Tube
UL File No.: E29179
CSA File No.: LR19980
Mates With: 70665 or 71995
Designed In: Inches

Electrical

Voltage: 40V
Current: 1.0A
Contact Resistance: 20 milliohms max.
Dielectric Withstanding Voltage: 1000V
Insulation Resistance: 100 Megohms min.

Mechanical

Contact Insertion Force: 84g max.
Mating Force: 60g nom.
Unmating Force: 20g min.
Durability: 5000 cycles

Physical

Housing: Glass-filled polymer, UL 94V-0
Contact: Beryllium Copper Alloy
Plating: Terminals—30µ" min. Gold over Nickel in contact area, 100µ" min. Tin over Nickel in PC tail area
Shields—100µ" min. bright Tin over Copper

| Circuits | Order No. | PC Tail Length | Lead-free |
|----------|----------------------------|----------------|-----------|
| 96 | 51-26-0001 | 2.34 (.092) | Yes |

1.90mm (.075") Pitch LFH™ Matrix 75 Shielded Plug

70665
96 Circuit
Right Angle

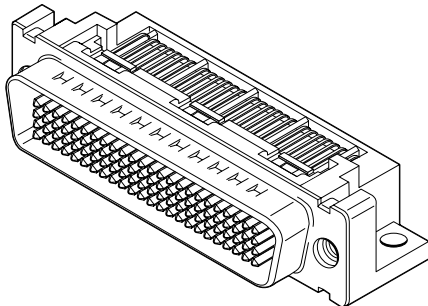

Features and Benefits

- High-performance, Low Force Helix terminal with contact layout .075 by .075"
- High cycle life from controlled plating and contact surfaces
- Suitable for high-density and high-performance applications
- 96-circuit same size as 50-pin standard D-sub for backshell hardware
- M3 threaded inserts for attaching various hardware options
- Docking hardware 71628 and 71629
- Jackposts 70982
- Surface Mount Compatible

Reference Information

Product Specification: PS-70660
Packaging: Tube
UL File No.: E29179
CSA File No.: LR19980
Mates With: 70660 or 71990
Designed In: Inches

Electrical

Voltage: 40V
Current: 1.0A
Contact Resistance: 20 milliohms max.
Dielectric Withstanding Voltage: 1000V
Insulation Resistance: 100 Megohms min.

Mechanical

Contact Insertion Force: 84g max.
Mating Force: 60g nom.
Unmating Force: 20g min.
Durability: 5000 cycles

Physical

Housing: Glass-filled polymer, UL 94V-0
Contact: Phosphor Bronze alloy
Plating: Terminals—30µ" min. Gold over Nickel in contact area, 100µ" min. Tin over Nickel in PC tail area
Shields—100µ" min. bright Tin over Nickel all over Copper

| Circuits | Order No. | PC Tail Length | Lead-free |
|----------|----------------------------|----------------|-----------|
| 96 | 51-26-0011 | 2.34 (.092) | Yes |

1.90mm (.075") Pitch LFH™ Matrix 75 Shielded Plug

70665
96 Circuit
Vertical

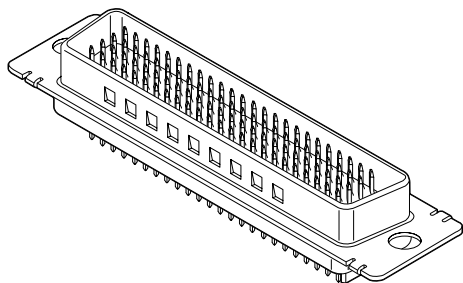

Features and Benefits

- High-performance, Low Force Helix terminal with contact layout .075 by .075"
- High cycle life form controlled plating and contact surfaces
- Suitable for high-density and high-performance applications
- 96-circuit same size as 50-pin standard D-sub for backshell hardware
- Surface Mount Compatible

Reference Information

Product Specification: PS-70660
Packaging: Tube
UL File No.: E29179
CSA File No.: LR19980
Mates With: 70660 or 71990
Designed In: Inches

Electrical

Voltage: 40V
Current: 1.0A
Contact Resistance: 20 milliohms max.
Dielectric Withstanding Voltage: 1000V.
Insulation Resistance: 100 Megohms min.

Mechanical

Contact Insertion Force: 84g max.
Mating Force: 60g nom.
Unmating Force: 20g min.
Durability: 5000 cycles

Physical

Housing: Glass-filled polymer, UL 94V-0
Contact: Phosphor Bronze alloy
Plating: Terminals—30µ" min. Gold over Nickel in contact area, 100µ" min. Tin over Nickel in PC tail area
Shields—100µ" min. bright Tin over Nickel all over Copper

| Circuits | Order No. | PC Tail Length | Lead-free |
|----------|----------------------------|----------------|-----------|
| 96 | 51-26-0011 | 2.34 (.092) | Yes |

I/O Products

1.90mm (.075") Pitch LFH™ Matrix 75 Plug Cable Kit

N 70665
Subassembly and
Terminal Sticks
96 and 130 Circuit

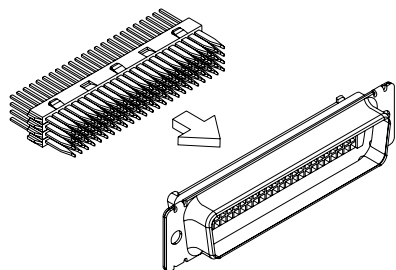

Features and Benefits

- Cable assemblies available from Molex
- Termination of a variety of wire types 26 to 36 AWG (depending on application)
- Wire terminated by direct weld or solder
- Terminal sticks sold separately
- 96-circuit same size as 50-pin standard D-sub for standard overmolding and back shell hardware

Reference Information

Packaging: Box and tray
Mates With: 70660 or 71990
Designed In: Inches

Electrical

Voltage: 40V
Current: 1.0A
Contact Resistance: 20 milliohms max.
Dielectric Withstanding Voltage: 1000V.
Insulation Resistance: 100 Megohms min.

Mechanical

Mating Force: 60g nom.
Unmating Force: 20g min.
Durability: 5000 cycles

Physical

Housing: Glass-filled polymer, UL 94V-0
Contact: Plug—Phosphor Bronze Alloy
Receptacle—Beryllium Copper Alloy
Plating: Terminals—30µ" min. Gold over Nickel in contact area, 100µ" min. Tin over Nickel in PC tail area
Shields—150µ" min. bright Tin over Nickel all over Copper flash

| Subassembly | | | |
|-------------|----------------------------|--------------------------------|-----------|
| Circuits | Order No. | Description | Lead-free |
| 96 | 51-26-0012 | I/O Plug Connector Subassembly | Yes |

| Terminal Sticks | | | | | |
|-----------------|----------------------------|-----------------------------------|-------------|------------------------------|-----------|
| Circuits | Order No. | Description | Trim Length | No. Required per Subassembly | Lead-free |
| 96 | 51-25-1005 | With Carrier | N/A | Four 24-Circuit Sticks | Yes |
| | 51-25-1012 | Trimmed to Length without Carrier | 3.30 (.130) | | |
| 130 | 51-25-1007 | With Carrier | N/A | Five 26-Circuit Sticks | |
| | 71989-2003 | Trimmed to Length without Carrier | 3.30 (.130) | | |

LFH™ Matrix 50 and 75 Docking Hardware

71628/71629

Guide Pin and Guide Sleeve

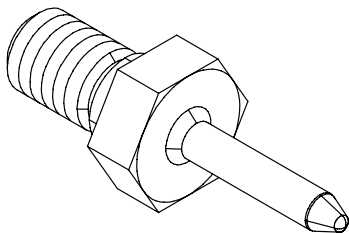

Features and Benefits

- For use with Matrix 50 and 75 products
- Guide pin is heat-treated steel material; guide sleeve is cold-drawn steel material
- Socket size 3/16"
- M3 external thread
- Suitable for docking applications
- Recommended panel thickness is .040" max.

Reference Information

Packaging: Bag
Designed In: Inches

Mechanical

Assembly Torque: 5 in.-lb max.

Physical

Plating: Nickel

| Guide Pin | | | |
|-----------------------------|-------------------|---------------|-----------|
| Order No. | Dimension | | Lead-free |
| | Mating Pin Length | Thread Length | |
| 71628-3000* | 11.68 (.460) | 4.37 (.172) | Yes |

| Guide Sleeve | | | |
|-----------------------------|---------------|--|-----------|
| Order No. | Dimension | | Lead-free |
| | Thread Length | | |
| 71629-4000* | 4.37 (.172) | | Yes |

* Lead-in .050" by 45° (alignment tolerance of 1.5mm radially) for docking applications

LFH™ Matrix 50 and 75 Hardware

70982

Panel Mount Hex Screw Kit

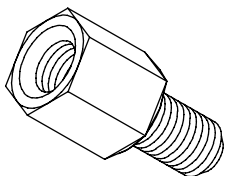

Features and Benefits

- For use with Matrix 50 and 75 products
- Socket size 3/16"
- 4-40 or M3 internal threads
- Recommended panel thickness is .025" max.

Reference Information

Packaging: Bag
Designed In: Inches

Mechanical

Assembly Torque: 5 in.-lb max.

| M3 External Threads | | | | | |
|----------------------------|----------|-----------------------|--------------------------|----------------|-----------|
| Kit Order No. | Quantity | Description | Plating | Overall Length | Lead-free |
| 70982-1002 | 2 | 4-40 internal threads | Tin | 10.01 (.394) | Yes |
| | 4 | Washer | | | |
| | 2 | Lockwasher | | | |
| | | Nut | | | |
| 70982-1003 | 1 | 4-40 internal threads | Yellow Chromate | 11.00 (.433) | Yes |
| 70982-1004 | | M3 internal threads | Tin | 10.01 (.394) | |
| 70982-1005 | | 4-40 internal threads | Clear Trivalent Chromate | | |

DMS-59™ Shielded I/O Cable Assembly

88759

DMS-59 To Dual VGA
DMS-59 To VGA/DVI Analog
DMS-59 To Dual DVI Analog
DMS-59 To Dual DVI Digital

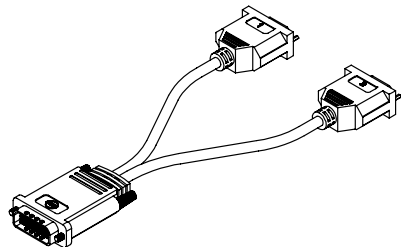

Features and Benefits

- Keyed (void pin number 58) to ensure exclusive mating of receptacle with DMS-59 cable assemblies
- Proven LFH™ (Low Force Helix) high-cycle contact interface system for reliable system life
- Cable assemblies are available in a variety of lengths and configurations

Reference Information

Product Specification: PS-88768-5300
Packaging: Bag
Mates With: DMS-59 receptacle
Designed In: Millimeters

Electrical

Voltage: 30V
Current: 1.0A
Contact Resistance: 50 milliohms max.
Dielectric Withstanding Voltage: 500V DC
Insulation Resistance: 100 Megohms min.

Mechanical

Insertion Force: 53N max.
Withdraw Force: 22N min.
Durability: 5000 cycles

Physical

Housing: White glass-filled LCP, UL 94V-0
Contact: Copper Alloy
Plating: Contact Area—0.75µm (30µ") min. Gold
Underplating: Nickel
Wire Gauge: 30 AWG

| Cable Length (mm) | Order No. | Cable Assembly Description | Lead-free |
|-------------------|----------------------------|--|-----------|
| 200 | 88768-5200 | DMS-59-Male to Two VGA-Female Cable Assembly | Yes |
| | 88768-5300 | DMS-59-Male to Two DVI-I-Female Cable Assembly | |
| | 88768-5400 | DMS-59-Male to VGA-Female + DVI-I-Female Cable Assembly | |
| 2000 | 88768-5500 | DMS-59-Male to Two DVI-D-Male Single Link Cable Assembly | Yes |
| 3000 | 88768-5510 | | |

www.molex.com/product/io/dms59.html

I/O Products

N

1.27mm (.050") Pitch TDP™ Triad Differential Pair Receptacle

74960

SMT, Right Angle

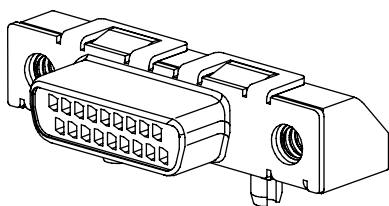

Features and Benefits

- Ideal for LVDS applications requiring differential pair capabilities
- The shielded, dual row interface offers high-speed and 100-ohm controlled impedance with data rates up to 5 Gbs
- Inline SMT leads on 0.64mm (.025") pitch provide direct PCB routing
- High cycle LFH™ shrouded contact system provides 2 points of contact for optimal signal integrity
- Optional jack posts available in 4-40 or M3 threads for use with jackscrews for positive mating retention

Reference Information

Product Specification: PS-74960-000
Packaging: Embossed Tape
Mates With: 75000 plug
Use With: 74962 jackposts
Designed In: Millimeters

Electrical

Voltage: 40V
Current: 1.5A
Contact Resistance: 20 milliohms max.
Dielectric Withstanding Voltage: 500V
Insulation Resistance: 100 Megohms min.
Differential Impedance:
2.5Gbps: 100 ± 10 ohms at 150psec risetime
5.0Gbps: 100 ± 18 ohms at 75psec risetime

Mechanical

Contact Insertion Force: 0.60N (0.13 lbf) per circuit
Insertion Force to PCB: 44.50N (10.00 lbf) total
Mating Force: 11.17N (2.51 lbf) per circuit
Unmating Force: 6.7N (1.5 lbf) per circuit
Normal Force: 75 g
Durability: 5,000 cycles

Physical

Housing: Black LCP, UL 94V-0
Contact: Copper Alloy
Plating: 15µ" min. Select Gold
Shield: Deep-drawn Steel

| Circuits | Order No. | Threaded Inserts* | Lead-free |
|----------|----------------------------|-------------------|-----------|
| 18 | 74960-2018 | 4-40 | Yes |
| 28 | 74960-2028 | | |
| 48 | 74960-2048 | | |

* Also available with M3 threaded inserts

1.27mm (.050") Pitch TDP™ Triad Differential Pair Cable Plug

75000

Wire Terminated

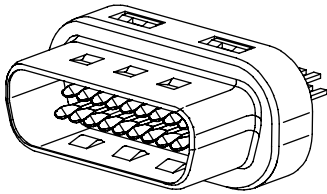

Features and Benefits

- Ideal for LVDS applications requiring differential pair capabilities
- The shielded, dual row interface offers high-speed and 100-ohm controlled impedance with data rates up to 5 Gbs
- First-mate/last-break pins 9 and 10 prevent damage to electrical circuitry when "hot plug" mating
- LFH™ contact design provides shallow mating angle, reducing insertion forces
- Terminates to 24 to 32 AWG high-performance wire through soldering or resistance welding
- Standard and custom cable assemblies available, 79925 series

Reference Information

Product Specification: PS-74960-000
Packaging: Tubes
Mates With: 74960 receptacle
Use With: 75115 backshell
Designed In: Millimeters

Electrical

Voltage: 40V
Current: 1.5A
Contact Resistance: 20 milliohms max.
Dielectric Withstanding Voltage: 500V
Insulation Resistance: 100 Megohms min.
Differential Impedance:
2.5Gbps: 100 ± 10 ohms at 150psec risetime
5.0Gbps: 100 ± 18 ohms at 75psec risetime

Mechanical

Contact Insertion Force: 0.60N (0.13 lbf) per circuit
Insertion Force to PCB: 44.50N (10.00 lbf) total
Mating Force: 11.17N (2.51 lbf) per circuit
Unmating Force: 6.7N (1.5 lbf) per circuit
Normal Force: 75g
Durability: 5,000 cycles

Physical

Housing: Black LCP, UL 94V-0
Contact: Copper Alloy
Plating: 15µ" min. Select Gold
Shield: Deep-drawn Steel

| Circuits | Order No. | Description | Lead-free |
|----------|----------------------------|---------------------------------------|-----------|
| 18 | 75000-1018 | Plug assembled with pre-trimmed tails | Yes |
| 28 | 75000-1028 | | |
| 48 | 75000-1048 | Plug assembled with pre-trimmed tails | |

1.27mm (.050") Pitch TDP™ Triad Differential Pair Die Cast Backshell

75115

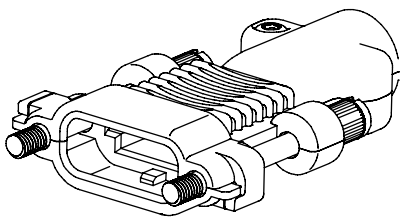

Features and Benefits

- Kit contains two-piece die cast shell and two threaded jackscrews for use with TDP Cable Plug Connector
- User-friendly strain relief eliminates secondary operations
- Ergonomic die-cast shell thumb grip and thumb rest for ease of mating and unmating
- Standard and custom cable assemblies available through Molex, 79925 series

Reference Information

Packaging: Bag
Mates With: 74960
Use With: 75000 and 74155
Designed In: Millimeters

Physical

Plating: Nickel

| Circuits | Order No. | Description | Cable Outside Diameter | Lead-free |
|----------|----------------------------|----------------------------------|------------------------|-----------|
| 18 | 75115-0018 | Black finish with 4-40 jackscrew | 7.78mm (.310") | Yes |
| 28 | 75115-0028 | | 8.51mm (.335") | |
| 48 | 75115-0048 | | 11.18mm (.440") | |

Note: Also available with M3 jackscrew option, contact Molex

MicroCross™ DVI Connector Systems

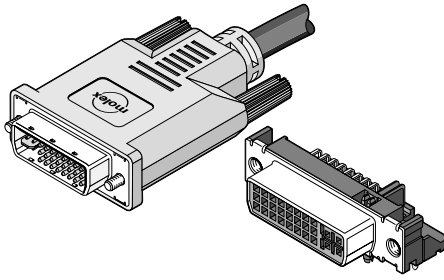

FEATURES

MicroCross Receptacles: DVI-D, DVI-A and DVI-I (74320) Plugs: DVI-D Single Link, DVI-D Dual Link, DVI-A, DVI-I Single Link and DVI-I Dual Link

- MicroCross coax design supports analog video
- LFHT™ contact design for high reliability
- DVI video I/O supports the DDWG (Digital Display Working Group) Digital Visual Interface standard
- Right angle and vertical receptacles as well as cable assemblies, adapters and plug components available for a complete system solution
- Surface Mount Compatible
- Saves space on the host unit by integrating functions in one connector
- Staggered contact mating for power, ground and signal sequencing
- Improved bandwidth performance— analog and digital
- Reduced crosstalk
- Impedance controlled for better high speed signal performance
- Field-proven reliability
- Provides a high cycle interface
- Reduces cable assembly need from multiple cables to one
- Fully shielded for RFI/EMI concerns
- Flexible termination capable of many wire sizes and types
- Both video connectors support plug-n-play
- First make, last break
- Protruding receptacle shield for ESD considerations

The Molex MicroCross connector family is based on an innovative use of “crossing” ground blades to provide high-speed electrical performance in a low cost connector format. It was chosen as the interface for the Digital Display Working Group (DDWG) Digital Visual Interface (DVI) standard.

DDWG’s DVI standard is grouped into two separate standards, the Digital Visual Interface-Analog/Digital (DVI-I) and the Digital Visual Interface-Digital (DVI-D). This standard provides the future direction for analog and digital video interfaces for the computer industry.

The MicroCross product line is comprised of the DVI-I, the DVI-D and the DVI-A connector systems. The DVI-I supports digital and analog video interfaces whereas the DVI-D only supports a digital video interface. DVI-A supports analog video interface.

The MicroCross product family fills the needs of the industry for an interconnect system that is low cost, provides a more reliable interface than the existing video I/O connectors, and most importantly, provides increased bandwidth and EMI performance. Where traditional connector designs begin to breakdown at 250 MHz, Molex’s MicroCross DVI can provide analog performance to 2.5 GHz. In digital applications, 1.65 Gbps of throughput is provided per data channel and DVI supports 9.9 Gbps over a dual link implementation. Utilizing Molex’s LFH redundant contact interface, the MicroCross provides a robust pin and shrouded receptacle design that will take the abuse in handling, provide a low connector insertion force and provide controlled contact interface surfaces, which renders reliability in high life-cycle applications through a variety of environmental conditions.

DVI provides the solution for higher digital and analog bandwidth requirements for video signaling from the host to the display. Data transfer remains in a digital format, thus eliminating conversion losses and increasing the capacity for high resolution monitors and flat panel displays.

The MicroCross Product Family Supports the Following Signal Sets:

DVI-I
Analog Video Output (RGB)
DDC
Up to 2 Links of TMDS*
H/V Sync
Hot Plug Detect

DVI-D
DDC
Up to 2 Links of TMDS*
Hot Plug Detect

DVI-A
Analog video output (RGB)
DDC
H/V Sync
Hot Plug Detect

The Electrical Performance of the MicroCross Coax Lines Support:

Impedance: $75\Omega \pm 10\%$
Crosstalk: Less than 2% @ 1V/1n
Bandwidth: 2.5 GHz (analog)

The Electrical Performance of the MicroCross Digital Lines Support:

Impedance: $100\Omega \pm 15\%$
Crosstalk: Less than 5% @ 1.65 Gbps channel data rate
Bandwidth:
DVI Single Link (4.95 Gbps or 1.65 Gbps per data pair) 3 data pairs
DVI Dual Link (9.9 Gbps or 1.65 Gbps per data pair) 6 data pairs

Note: Zero skew within data pairs

MicroCross™ DVI Connector System Digital Visual Interface Standard

Features

- Through Hole
- Housings: Glass-filled thermoplastic, UL 94V-0
- Contacts: Copper Alloy
- Plating: Gold flash or 30µ" Gold

Specifications

Voltage: 40V
Current: 3.0A

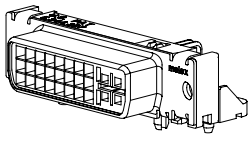
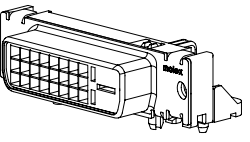
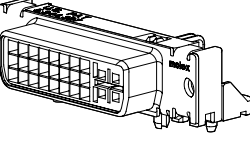
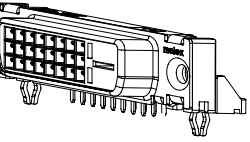
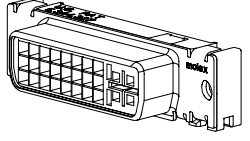
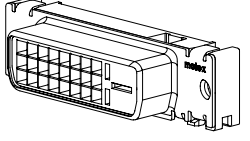
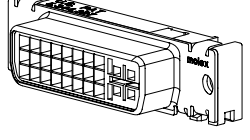
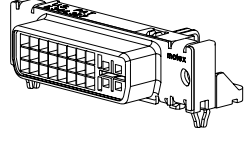
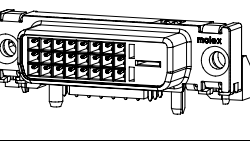
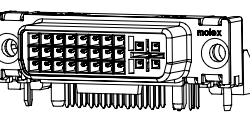
| | Description | Options | Order No. | |
|---|---|-------------------------|----------------------------|----------------------------|
| | | | Gold Flash | 30µ" Gold |
|  | DVI-I Right Angle Digital/Analog Receptacle | PCB Retention: Peg | 74320-1004 | 74320-1000 |
|  | DVI-D Right Angle Digital Receptacle | PCB Retention: Peg | 74320-4004 | 74320-4000 |
|  | DVI-A Right Angle Analog Receptacle | PCB Retention: Peg | 74320-1009 | 74320-1008 |
|  | DVI-D Right Angle Digital ATX Receptacle with Forklocks | PCB Retention: Forklock | 74320-9004 | 74320-9000 |
|  | DVI-I Vertical Digital/Analog Receptacle | PCB Retention: Peg | 74320-3004 | 74320-3000 |
|  | DVI-D Vertical Digital Receptacle | PCB Retention: Peg | 74320-5004 | 74320-5000 |
|  | DVI-A Vertical Analog Receptacle | PCB Retention: Peg | 74320-3009 | 74320-3008 |
|  | DVI-I Right Angle Digital/Analog Receptacle with Forklocks | PCB Retention: Forklock | 74320-9014 | 74320-9010 |
|  | DVI-D Right Angle Digital Extended Height Receptacle | PCB Retention: Peg | 74320-2010 | 74320-2011 |
|  | DVI-I Right Angle Digital/Analog Extended Height Receptacle | PCB Retention: Peg | 74320-2020 | 74320-2021 |

I/O Products

N

MicroCross™ DVI-A Analog Visual Interface Receptacle Header and Hardware

74320 Panel Mount Through Hole Vertical

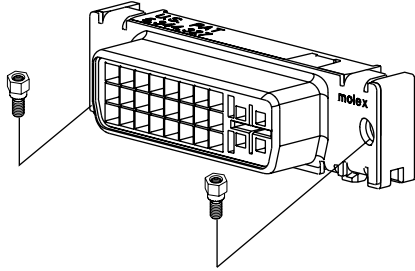

| Order No. | Plating | Lead-free |
|----------------------------|------------|-----------|
| 74320-3008 | 30µ" Gold | Yes |
| 74320-3009 | Gold Flash | |

Please contact Molex for additional tail length options

Features and Benefits

- Supports analog signal and offers excellent EMI/RFI performance
- Plug and play interface
- LFH™ contact design is rugged and reliable
- DDWG DVI standard interface compliant
- The MicroCross coaxial section supports a high bandwidth up to 2.5 GHz analog signal
- Selectively loaded circuits reduce cost

Reference Information

Product Specification: PS-74320-001
Packaging: Tray
UL File No.: E29179
CSA File No.: LR19980
Mates with: 88741, 74323 and other plug components
Designed In: Inches

Electrical

Voltage: 40V
Current: 3.0A
Contact Resistance: 20 milliohms max.
Dielectric Withstanding Voltage: 500V
Insulation Resistance: 1000 Megohms min.

Mechanical

Contact Retention to Housing: 1 lb. min.
Insertion Force to PCB: 10 lb. max.
Mating Force: 10 lb. max.
Unmating Force: 2.2 lb. min.
Durability: 100 cycles

Physical

Housing: Glass-filled thermoplastic, UL 94V-0
Contact: Copper Alloy
Plating: Contact—30µ" Gold or Gold flash in contact area and 100µ" or 150µ" Tin in tail area over Nickel overall
Shields—100µ" bright Tin over Copper overall

MicroCross™ DVI-A Analog Visual Interface Receptacle Header and Hardware

74320 Panel Mount Through Hole Right Angle

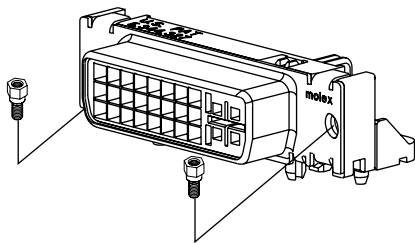

| Order No. | Plating | Lead-free |
|----------------------------|------------|-----------|
| 74320-1008 | 30µ" Gold | Yes |
| 74320-1009 | Gold Flash | |

Please contact Molex for additional tail length options

Features and Benefits

- Supports analog signal and offers excellent EMI/RFI performance
- Plug and play interface
- LFH™ contact design is rugged and reliable
- DDWG DVI standard interface compliant
- The MicroCross coaxial section supports a high bandwidth up to 2.5 GHz analog signal
- Selectively loaded circuits reduce cost

Reference Information

Product Specification: PS-74320-001
Packaging: Tray
UL File No.: E29179
CSA File No.: LR19980
Mates with: 88741, 74323 and other plug components
Designed In: Inches

Electrical

Voltage: 40V
Current: 3.0A
Contact Resistance: 20 milliohms max.
Dielectric Withstanding Voltage: 500V
Insulation Resistance: 1000 Megohms min.

Mechanical

Contact Retention to Housing: 1 lb. min.
Insertion Force to PCB: 10 lb. max.
Mating Force: 10 lb. max
Unmating Force: 2.2 lb. min.
Durability: 100 cycles

Physical

Housing: Glass-filled thermoplastic, UL 94V-0
Contact: Copper Alloy
Plating: Contact—30µ" Gold or Gold flash in contact area and 100µ" or 150µ" Tin in tail area over Nickel overall
Shields—100µ" bright Tin over Copper overall

MicroCross™ DVI-D Digital Visual Interface Receptacle Header and Hardware

74320 Panel Mount Through Hole Vertical

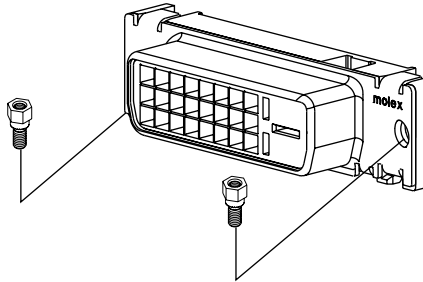

| Order No. | Plating | Lead-free |
|----------------------------|------------|-----------|
| 74320-5000 | 30µ" Gold | Yes |
| 74320-5004 | Gold Flash | |

Features and Benefits

- Supports digital signals and offers excellent EMI/RFI performance
- Plug and play interface
- LFH™ contact design is rugged and reliable
- DDWG DVI standard interface
- Supports 4.95 Gbps over a single link and 9.9 Gbps performance over a dual link implementation
- Narrow key slot for polarization

Reference Information

Product Specification: PS-74320-001
 Packaging: Tray
 UL File No.: E29179
 CSA File No.: LR19980
 Mates with: Versions of 88741, 74323 and other plug components
 Designed In: Inches

Electrical

Voltage: 40V
 Current: 3.0A
 Contact Resistance: 20 milliohms max.
 Dielectric Withstanding Voltage: 500V
 Insulation Resistance: 1,000 Megohms min.

Mechanical

Contact Retention to Housing: 1 lb. min.
 Insertion Force to PCB: 10 lb. max.
 Mating Force: 10 lb. max.
 Unmating Force: 2.2 lb. min.
 Durability: 100 cycles

Physical

Housing: Glass-filled thermoplastic, UL 94V-0
 Contact: Copper Alloy
 Plating: Contact—30µ" Gold or Gold flash in contact area and 100µ" or 150µ" Tin in tail area over Nickel overall
 Shields—100µ" bright Tin over Copper overall

MicroCross™ DVI-D Digital Visual Interface Receptacle Header and Hardware

74320 Panel Mount Through Hole Right Angle ATX with Forklocks

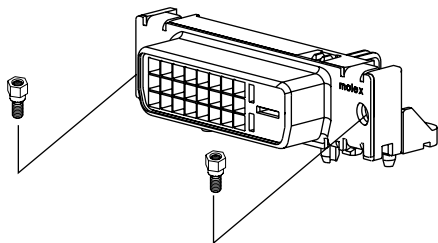

| Order No. | Plating | Lead-free |
|----------------------------|------------|-----------|
| 74320-9000 | 30µ" Gold | Yes |
| 74320-9004 | Gold Flash | |

Please contact Molex for additional tail length options

Features and Benefits

- Supports digital signals and offers excellent EMI/RFI performance
- Plug and play interface
- LFH™ contact design is rugged and reliable
- DDWG DVI standard interface
- Supports 4.95 Gbps over a single link and 9.9 Gbps performance over a dual link implementation
- Narrow key slot for polarization

Reference Information

Product Specification: PS-74320-001
 Packaging: Tray
 UL File No.: E29179
 CSA File No.: LR19980
 Mates with: Versions of 88741, 74323 and other plug components
 Designed In: Inches

Electrical

Voltage: 40V
 Current: 3.0A
 Contact Resistance: 20 milliohms max.
 Dielectric Withstanding Voltage: 500V
 Insulation Resistance: 1,000 Megohms min.

Mechanical

Contact Retention to Housing: 1 lb. min.
 Insertion Force to PCB: 10 lb. max.
 Mating Force: 10 lb. max.
 Unmating Force: 2.2 lb. min.
 Durability: 100 cycles

Physical

Housing: Glass-filled thermoplastic, UL 94V-0
 Contact: Copper Alloy
 Plating: Contact—30µ" Gold or Gold flash in contact area and 100µ" or 150µ" Tin in tail area over Nickel overall
 Shields—100µ" bright Tin over Copper overall

MicroCross™ DVI-D Digital Visual Interface Receptacle Header and Hardware

74320

**Panel Mount Through Hole
Right Angle**

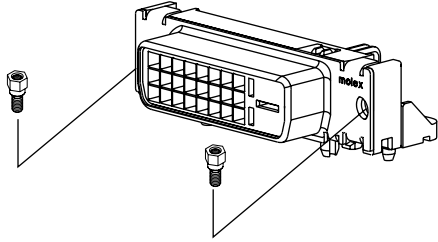

| Order No. | Plating | Lead-Free |
|----------------------------|------------|-----------|
| 74320-4000 | 30µ" Gold | Yes |
| 74320-4004 | Gold Flash | |

Please contact Molex for additional tail length options

Features and Benefits

- Supports digital signals and offers excellent EMI/RFI performance
- Plug and play interface
- LFH™ contact design is rugged and reliable
- DDWG DVI standard interface
- Supports 4.95 Gbps over a single link and 9.9 Gbps performance over a dual link implementation
- Narrow key slot for polarization

Reference Information

Product Specification: PS-74320-001
 Packaging: Tray
 UL File No.: E29179
 CSA File No.: LR19980
 Mates With: Versions of 88741, 74323 and other plug components
 Designed In: Inches

Electrical

Voltage: 40V
 Current: 3.0A
 Contact Resistance: 20 milliohms max.
 Dielectric Withstanding Voltage: 500V
 Insulation Resistance: 1000 Megohms min.

Mechanical

Contact Retention to Housing: 1 lb. min.
 Insertion Force to PCB: 10 lb. max.
 Mating Force: 10 lb. max.
 Unmating Force: 2.2 lb. min.
 Durability: 100 cycles

Physical

Housing: Glass-filled thermoplastic, UL 94V-0
 Contact: Copper Alloy
 Plating: Contact—30µ" Gold or Gold flash in contact area and 100µ" or 150µ" Tin in tail area over Nickel overall
 Shields—100µ" bright Tin over Copper overall

MicroCross™ DVI-D Digital Visual Interface Receptacle Header and Hardware

74320

**Panel Mount Through Hole
Extended Height
Right Angle**

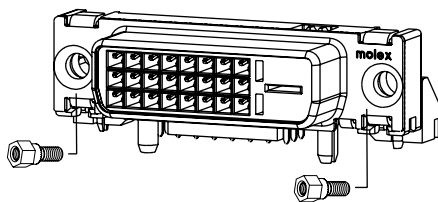

| Order No. | Plating | Lead-free |
|----------------------------|------------|-----------|
| 74320-2010 | Gold Flash | Yes |
| 74320-2011 | 30µ" Gold | |

Please contact Molex for additional tail length options

Features and Benefits

- Supports digital signals and offers excellent EMI/RFI performance
- Plug and play interface
- LFH™ contact design is rugged and reliable
- DDWG DVI standard interface
- Supports 4.95 Gbps over a single link and 9.9 Gbps over a dual link implementation
- Narrow key slot for polarization

Reference Information

Product Specification: PS-74320-001
 Packaging: Tray
 UL File No.: E29179
 CSA File No.: LR19980
 Mates with: Versions of 88741, 74323 and other plug components
 Designed in: Inches

Electrical

Voltage: 40V
 Current: 3.0A
 Contact Resistance: 20 milliohms max.
 Dielectric Withstanding Voltage: 500V
 Insulation Resistance: 1000 Megohms min.

Mechanical

Contact Retention to Housing: 1 lb min.
 Insertion Force to PCB: 10 lb max.
 Mating Force: 10 lb max.
 Unmating Force: 2.2 lb min.
 Durability: 100 cycles

Physical

Housing: Glass-filled thermoplastic, UL 94V-0
 Contact: Copper Alloy
 Plating: Contact—30µ" Gold or Gold flash in contact area and 100µ" or 150µ" Tin in tail area over Nickel overall
 Shields—100µ" bright Tin over Copper overall

MicroCross™ DVI-I Digital/Analog Visual Interface Receptacle Header and Hardware

74320 Panel Mount Through Hole Vertical

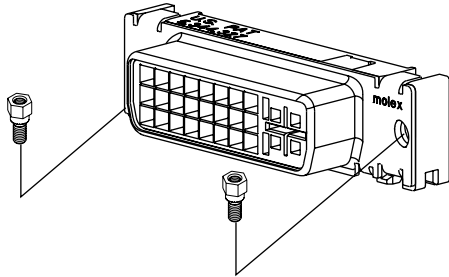

| Order No. | Plating | Lead-free |
|----------------------------|------------|-----------|
| 74320-3000 | 30µ" Gold | Yes |
| 74320-3004 | Gold Flash | |

Please contact Molex for additional tail length options

Features and Benefits

- Supports both analog and digital signals
- Plug and play interface
- Excellent EMI/RFI performance
- LFH™ contact design is rugged and reliable
- DDWG DVI standard interface
- The digital section supports 4.95 Gbps over a single link and 9.9 Gbps over a dual link.
- The MicroCross coax section supports a high-bandwidth of up to 2.5 GHz analog signal

Reference Information

Product Specification: PS-74320-001
Packaging: Tray
UL File No.: E29179
CSA File No.: LR19980
Mates with: 88741, 74323 and other plug components
Designed In: Inches

Electrical

Voltage: 40V
Current: 3.0A
Contact Resistance: 20 milliohms max.
Dielectric Withstanding Voltage: 500V
Insulation Resistance: 1000 Megohms min.

Mechanical

Contact Retention to Housing: 1 lb. min.
Insertion Force to PCB: 10 lb. max.
Mating Force: 10 lb. max.
Unmating Force: 2.2 lb. min.
Durability: 100 cycles

Physical

Housing: Glass-filled thermoplastic, UL 94V-0
Contact: Copper Alloy
Plating: Contact—30µ" Gold or Gold flash in contact area and 100µ" or 150µ" Tin in tail area over Nickel overall
Shields—100µ" bright Tin over Copper overall

MicroCross™ DVI-I Digital/Analog Visual Interface Receptacle Header and Hardware

74320 Panel Mount Through Hole Right Angle with Forklocks

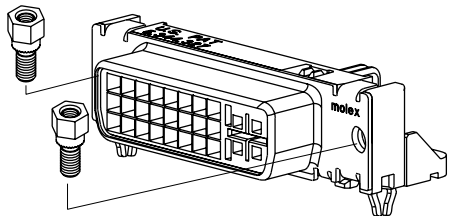

| Order No. | Plating | Lead-free |
|----------------------------|------------|-----------|
| 74320-9010 | 30µ" Gold | Yes |
| 74320-9014 | Gold Flash | |

Please contact Molex for additional tail length options

Features and Benefits

- Supports both analog and digital signals
- Excellent EMI/RFI performance
- Plug and play interface
- LFH™ contact design is rugged and reliable
- DDWG DVI standard interface
- The digital section supports 4.95 Gbps over a single link and 9.9 Gbps over a dual link
- The MicroCross coax section supports a high-bandwidth of up to 2.5 GHz analog signal

Reference Information

Product Specification: PS-74320-001
Packaging: Tray
UL File No.: E29179
CSA File No.: LR19980
Mates with: 88741, 74323 and other plug components
Designed In: Inches

Electrical

Voltage: 40V
Current: 3.0A
Contact Resistance: 20 milliohms max.
Dielectric Withstanding Voltage: 500V
Insulation Resistance: 1000 Megohms min.

Mechanical

Contact Retention to Housing: 1 lb. min.
Insertion Force to PCB: 10 lb. max.
Mating Force: 10 lb. max.
Unmating Force: 2.2 lb. min.
Durability: 100 cycles

Physical

Housing: Glass-filled thermoplastic, UL 94V-0
Contact: Copper Alloy
Plating: Contact—30µ" Gold or Gold flash in contact area and 100µ" or 150µ" Tin in tail area over Nickel overall
Shields—100µ" bright Tin over Copper overall

MicroCross™ DVI-I Digital/Analog Visual Interface Receptacle Header and Hardware

74320

**Panel Mount Through Hole
Right Angle**

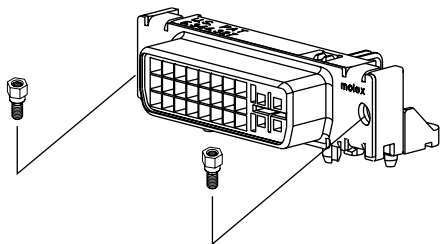

| Order No. | Plating | Lead-free |
|----------------------------|------------|-----------|
| 74320-1000 | 30µ" Gold | Yes |
| 74320-1004 | Gold Flash | |

Please contact Molex for additional tail length options

Features and Benefits

- Supports both analog and digital signals
- Plug and play interface
- Excellent EMI/RFI performance
- LFH™ contact design is rugged and reliable
- DDWG DVI standard interface
- The digital section supports 4.95 Gbps over a single link and 9.9 Gbps over a dual link.
- The MicroCross coax section supports a high-bandwidth of up to 2.5 GHz analog signal

Reference Information

Product Specification: PS-74320-001
Packaging: Tray
UL File No.: E29179
CSA File No.: LR19980
Mates With: 88741, 74323 and other plug components
Designed In: Inches

Electrical

Voltage: 40V
Current: 3.0A
Contact Resistance: 20 milliohms max.
Dielectric Withstanding Voltage: 500V
Insulation Resistance: 1000 Megohms min.

Mechanical

Contact Retention to Housing: 1 lb. min.
Insertion Force to PCB: 10 lb. max.
Mating Force: 10 lb. max.
Unmating Force: 2.2 lb. min.
Durability: 100 cycles

Physical

Housing: Glass-filled thermoplastic, UL 94V-0
Contact: Copper Alloy
Plating: Contact—30µ" Gold or Gold flash in contact area and 100µ" or 150µ" Tin in tail area over Nickel overall
Shields—100µ" bright Tin over Copper overall

MicroCross™ DVI-I Digital/Analog Visual Interface Receptacle Header and Hardware

74320

**Panel Mount, Through Hole,
Extended Height
Right Angle**

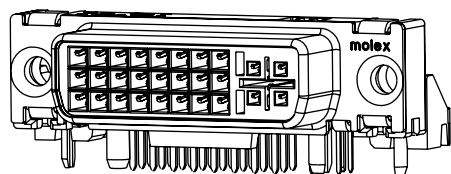

| Order No. | Plating | Lead-free |
|----------------------------|------------|-----------|
| 74320-2020 | Gold Flash | Yes |
| 74320-2021 | 30µ" Gold | |

Contact Molex for additional tail length options.

Features and Benefits

- Supports both analog and digital signals
- Plug and play interface
- Excellent EMI/RFI performance
- LFH™ contact design is rugged and reliable
- DDWG DVI standard interface
- The digital section supports 4.95 Gbps over a single link and 9.9 Gbps over a dual link.
- The MicroCross coax section supports a high-bandwidth of up to 2.5 GHz analog signal

Reference Information

Product Specification: PS-74320-001
Packaging: Tray
UL File No.: E29179
CSA File No.: LR19980
Mates With: 88741, 74323 and other plug components
Designed In: Inches

Electrical

Voltage: 40V
Current: 3.0A
Contact Resistance: 20 milliohms max.
Dielectric Withstanding Voltage: 500V
Insulation Resistance: 1000 Megohms min.

Mechanical

Contact Retention to Housing: 1 lb. min.
Insertion Force to PCB: 10 lb. max.
Mating Force: 10 lb. max.
Unmating Force: 2.2 lb. min.
Durability: 100 cycles

Physical

Housing: Glass-filled thermoplastic, UL 94V-0
Contact: Copper Alloy
Plating: Contact—30µ" Gold or Gold flash in contact area and 100µ" or 150µ" Tin in tail area over Nickel overall
Shields—100µ" bright Tin over Copper overall

MicroCross™ DVI Digital Visual Interface, Shielded I/O Cable Assembly

88741

DVI Cable Assembly and DVI Adapter

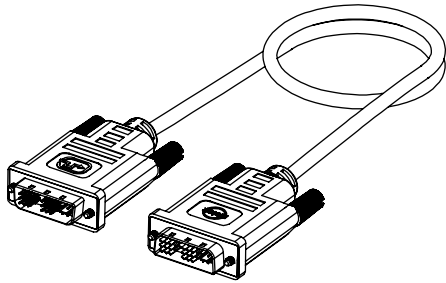

Features and Benefits

- Full shield provides EMI/RFI protection
- Transmits data at speeds up to 1.65 Gbps per differential pair
- LFH™ (Low Force Helix) rugged contacts offer increased life cycle durability, and mechanical and electrical reliability
- Detent feature provides grounding and secure mating retention
- Jackscrew provides positive lock to mating connector with thread 4-40 UNC-2A

Reference Information

Product Specification: PS-74320-001 and PS-88741-8800
Packaging: Bag
Mates With: 74320 receptacle
Designed In: Millimeters

Electrical

Voltage: 40V
Current: 3.0A
Contact Resistance: 20 milliohms max.
Dielectric Withstanding Voltage: 500V DC
Insulation Resistance: 1000 Megohms min.

Mechanical

Mating Force: 4.5kgf max.
Unmating Force: 1.0kgf min./4.0kgf max.
Durability: 100 cycles

Physical

Contact: Copper Alloy
Plating: Contact Area—0.75µm (30µ") min. Gold
Underplating: Nickel
Wire Gauge: 28 AWG

DVI Cable Assembly

| Description | Order No. | | | | | | | |
|------------------------------------|----------------------------------|-------------|---------------|---------------|----------------------------------|----------------|------------|------------|
| | DVI-Digital | P&D-Digital | DFP | Captive Cable | DVI-Digital/Analog | DVI-I-Analog | VGA | P&D-Analog |
| DVI-Digital To | 88741-80XX Single Link (TMDS) | 88741-85XX | 88741-86XX | 88741-96XX | | | | |
| | 88741-81XX Dual Link (TMDS) | | | | | | | |
| DVI-Digital/Analog To | | | | | 88741-90XX Single Link (TMDS) | | | |
| DVI-Analog To | | | | | | 88741-82XX | 88741-83XX | 88741-84XX |
| Replace XX with order number code: | | | | | | | | |
| | 2m (6.56 ft.) | | 3m (9.84 ft.) | | | 5m (16.40 ft.) | | |
| Black | 00 | | 10 | | | 20 | | |
| White | 01 | | 11 | | | 21 | | |

DVI Adapter

| Description | Order No. | | | |
|--------------------|----------------------------|----------------------------|----------------------------|-------------------------------------|
| | DVI-Digital to P&D-Digital | DVI-Digital to DFP | DVI-Analog to VGA | DVI-I-Analog/Digital to DVI-Digital |
| Plug to Receptacle | 88741-8900 | 88741-8800 | 88741-8700 | |
| Receptacle to Plug | 88741-9200 | 88741-9300 | 88741-9100 | 88741-9400 |

1.27mm (.050") Pitch Commercial Micro-D Plug

83611/83612/83614
Vertical

Features and Benefits

- Economical solution for commercial and industrial applications requiring the density of a microminiature connector
- Rugged commercial design with a metal interface and grounding tabs for improved mechanical and electrical shield conditions

Reference Information

UL File No.: E34763

Electrical

Current: 1.0A

Contact Resistance: 8 milliohms max.

Mechanical

Contact Engagement Force: 0.5 oz. min. to 8.6 oz. max.

Unmating Force: 0.5 oz. min.

Physical

Housing: Shell—304 Stainless Steel

Insulator—LCP, UL 94V-0

Contact: Pin—Gold-plated Beryllium Copper

Jackpost: Stainless Steel

| Circuits | Order No. | | | Lead-free |
|----------|----------------------------|----------------------------|----------------------------|-----------|
| | With Jackpost | Without Jackpost | Jackpost | |
| 9 | 83611-9023 | 83611-9206 | 83041-0005 | Yes |
| 15 | 83612-9024 | 83612-9205 | | |
| 25 | 83614-9016 | 83612-9202 | | |

I/O Products

1.27mm (.050") Pitch Commercial Micro-D Plug

83611/83612/83614
Right Angle

Features and Benefits

- Economical solution for commercial and industrial applications requiring the density of a microminiature connector
- Rugged commercial design with a metal interface and grounding tabs for improved mechanical and electrical shield conditions

Reference Information

UL File No.: E34763

Electrical

Current: 1.0A

Contact Resistance: 8 milliohms max.

Mechanical

Contact Engagement Force: 0.5 oz. min. to 8.6 oz. max.

Unmating Force: 0.5 oz. min.

Physical

Housing: Shell—304 Stainless Steel

Insulator—LCP, UL 94V-0

Contact: Pin—Gold-plated Beryllium Copper

Jackpost: Stainless Steel

| Circuits | Order No. | | | Lead-free |
|----------|----------------------------|----------------------------|----------------------------|-----------|
| | With Jackpost | Without Jackpost | Jackpost | |
| 9 | 83611-9006 | 83611-9016 | 83041-0005 | Yes |
| 15 | 83612-9020 | 83612-9022 | | |
| 25 | 83614-9012 | 83614-9014 | | |

1.27mm (.050") Pitch Commercial Micro-D Plug

83619

Right Angle, Dual Stack

Features and Benefits

- Economical solution for commercial and industrial applications requiring the density of a microminiature connector
- Rugged commercial design with a metal interface and grounding tabs for improved mechanical and electrical shield conditions

Reference Information

UL File No.: E34763

Electrical

Current: 1.0A
Contact Resistance: 8 milliohms max.

Mechanical

Contact Engagement Force: 0.5 oz. min. to 8.6 oz. max.
Unmating Force: 0.5 oz. min.

Physical

Housing: Shell—304 Stainless Steel
Insulator—LCP, UL 94V-0
Contact: Pin—Gold-plated Beryllium Copper
Jackpost: Stainless Steel

| Circuits | Order No. | | | Lead-free |
|----------|----------------------------|----------------------------|----------------------------|-----------|
| | With Jackpost | Without Jackpost | Jackpost | |
| 9 | 83619-9003 | 83619-9200 | 83041-0005 | Yes |
| 15 | 83619-9010 | 83619-9201 | | |
| 25 | 83619-9011 | 83619-9202 | | |

www.molex.com/product/commercial_micro_d.html

1.27mm (.050") Pitch Commercial Micro-D Cable Receptacle

83421/83422/83424

Assembled

Features and Benefits

- Economical solution for commercial applications requiring the density of a microminiature connector

Reference Information

UL File No.: E34763

Electrical

Current: 1.0A
Contact Resistance: 8 milliohms max.

Mechanical

Contact Engagement Force: 0.5 oz. min. to 8.6 oz. max.
Unmating Force: 0.5 oz. min.

Physical

Housing: Shell—Nickel-plated 1008LC Steel
Insulator—LCP, UL 94V-0
Contact: Socket—Gold-plated Copper alloy
Boot: Santoprene
Jackscrew: Stainless Steel

| Circuits | Order No. | | | Description | Lead-free |
|----------|----------------------------|----------------------------|----------------------------|---|-----------|
| | 18"~1" | 36"~1" | 72"~1" | | |
| 9 | 83421-9042 | 83421-9043 | 83421-9044 | 9 Circuit CMD Single End Cable Assembly | Yes |
| 15 | 83422-9007 | 83422-9013 | 83422-9018 | 15 Circuit CMD Single End Cable Assembly | |
| 25 | 83424-9019 | 83424-9020 | 83424-9021 | 25 Circuit CMD Single End Cable Assembly | |
| 9 | 83421-9049 | 83421-9050 | 83421-9051 | 9 Circuit CMD to 9 Circuit CMD Cable Assembly | |
| 15 | 83422-9053 | 83422-9054 | 83422-9055 | 15 Circuit CMD to 15 Circuit CMD Cable Assembly | |
| 25 | 83424-9057 | 83424-9058 | 83424-9059 | 25 Circuit CMD to 25 Circuit CMD Cable Assembly | |
| 9 | 83421-9039 | 83421-9040 | 83421-9041 | 9 Circuit CMD to 9 Circuit Female Standard D-Sub Cable Assembly | |
| 15 | 83422-9056 | 83422-9057 | 83422-9058 | 15 Circuit CMD to 15 Circuit Female Standard D-Sub Cable Assembly | |
| 25 | 83424-9063 | 83424-9064 | 83424-9065 | 25 Circuit CMD to 25 Circuit Female Standard D-Sub Cable Assembly | |
| 9 | 83421-9036 | 83421-9037 | 83421-9038 | 9 Circuit CMD to 9 Circuit Male Standard D-Sub Cable Assembly | |
| 15 | 83422-9059 | 83422-9060 | 83422-9061 | 15 Circuit CMD to 15 Circuit Male Standard D-Sub Cable Assembly | |
| 25 | 83424-9060 | 83424-9061 | 83424-9062 | 25 Circuit CMD to 25 Circuit Male Standard D-Sub Cable Assembly | |

Cable = 28 AWG-PVC Jacket - shielded -80° - 300V - color coded per UL 2464 -Jacket Black

1.27mm (.050") Pitch Commercial Micro-D Cable Receptacle

**83421/83422/83424
Kit**

Features and Benefits

- Economical solution for commercial and industrial applications requiring the density of a microminiature connector
- "Crimp and poke" configuration designed for hand or semi-automatic crimping

Reference Information

UL File No.: E34763

Electrical

Current: 1.0A

Contact Resistance: 8 milliohms max.

Mechanical

Contact Engagement Force: 0.5 oz. min. to 8.6 oz. max.

Unmating Force: 0.5 oz. min.

Physical

Housing: Shell—Nickel-plated 1008LC Steel

Insulator—LCP, UL 94V-0

Contact: Socket—Gold-plated Beryllium Copper

Boot: Santoprene

Jackscrew: Stainless Steel

| Circuits | Order No. | Lead-free |
|----------|----------------------------|-----------|
| 9 | 83421-9014 | Yes |
| 15 | 83422-9014 | |
| 25 | 83423-9014 | |

Terminals

83000*

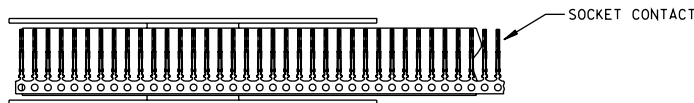

| Order No. | Description |
|----------------------------|-------------------|
| 83000-9502 | 2,500 Piece Reel |
| 83000-9503 | 50,000 Piece Reel |
| 83000-0083 | Loose |

* Use with 83421/83422/83424

D-Subminiature Shielded I/O PCB Receptacle

48201

**Female, Right Angle
Through Hole**

Features and Benefits

- Beveled metal pins provide positive PCB retention force
- Metal shell provides EMI/RFI shielding
- Intermateable with industry standard receptacles

Reference Information

Product Specification: PS-48201-001
Packaging: Tray
Mates With: 48202
Designed In: Millimeters

Electrical

Voltage: 300V DC
Current: 1.0A
Contact Resistance: 20 milliohms max.
Dielectric Withstanding Voltage: 500V AC
Insulation Resistance: 1000 Megohms min.

Mechanical

Contact Retention Force: 22.24N
Durability: Gold Flash—600 cycles
30µ" Gold—1000 cycles

Physical

Housing: Glass-filled polyester, UL 94V-0
Contact: Phosphor Bronze
Plating: Solder Tail Area—Tin
Underplating: 50µ" Nickel
PCB Thickness: 1.60mm (.062")

| Circuits | Order No. | Lock to Mating Part | Plating Contact | Lead-free |
|----------|----------------------------|--|-----------------|-----------|
| 9 | 48201-6041 | 4-40 Round Inner Thread Screws Included | 30µ" Gold | Yes |
| | 48201-6046 | 4-40 Hex Internal Thread Screws Included | | |
| | 48201-6043 | 4-40 Hex Internal Thread Screws Assemble | Gold Flash | |
| | 48201-6062 | Screw Hole, Threaded | | |
| 15 | 48201-6158 | M3 Inner Thread Screws Included | 15µ" Gold | |
| | 48201-6157 | M2.6 Inner Thread Screws Included | | |
| | 48201-6156 | 4-40 Hex Internal Thread Screws Included | | |
| | 48201-6155 | M3 Inner Thread Screws Assemble | | |
| | 48201-6154 | M2.6 Inner Thread Screws Assemble | | |
| | 48201-6153 | 4-40 Hex Internal Thread Screws Assemble | | |
| | 48201-6152 | Screw Hole, Threaded | Gold Flash | |
| | 48201-6166 | 4-40 Hex Internal Thread Screws Included | | |
| 25 | 48201-6367 | M2.6 Inner Thread Screws Included | Gold Flash | |
| | 48201-6366 | 4-40 Hex Internal Thread Screws Included | | |
| | 48201-6365 | M3 Inner Thread Screws Assemble | | |
| | 48201-6364 | M2.6 Inner Thread Screws Assemble | | |
| | 48201-6363 | 4-40 Hex Internal Thread Screws Assemble | | |
| | 48201-6362 | Screw Hole, Thread | | |
| | 48201-6368 | M3 Inner Thread Screws Included | | |

D-Subminiature Shielded I/O PCB Plug

48202

Male, Right Angle Through Hole

Features and Benefits

- Beveled metal pins provide positive PCB retention
- Indents in metal shell ensure reliable grounding
- Metal shell provides EMI/RFI shielding
- Interchangeable with industry standard receptacles

Reference Information

Product Specification: PS-48201-001
 Packaging: Tray
 Mates With: 48201
 Designed In: Millimeters

Electrical
 Voltage: 300V DC
 Current: 1.0A
 Contact Resistance: 20 milliohms max.
 Dielectric Withstanding Voltage: 500V AC
 Insulation Resistance: 1000 Megohms min.

Mechanical

Contact Insertion Force: 22.25N
 Durability: Gold Flash—600 cycles
 30µ" Gold —1000 cycles

Physical

Housing: Glass-filled polyester, UL 94V-0
 Contact: Brass
 Plating: Solder Tail Area—Tin
 Underplating: 50µ" Nickel
 PCB Thickness: 1.60mm (.062")

| Circuits | Order No. | Lock to Mating Part | Plating Contact | Lead-free |
|----------|----------------------------|---|-----------------|-----------|
| 9 | 48202-6041 | 4-40 Round Inner Thread Screws Included | 30µ" Gold | Yes |
| | 48202-6042 | Screw Hole, Threaded | | |
| | 48202-6043 | 4-40 Hex Internal Thread Screws Assembled | | |
| | 48202-6044 | M2.6 Inner Thread Screws Assembled | | |
| | 48202-6045 | M3 Inner Thread Screws Assembled | | |
| | 48202-6046 | 4-40 Hex Internal Thread Screws Included | | |
| | 48202-6047 | M2.6 Inner Thread Screws Included | | |
| | 48202-6048 | M3 Inner Thread Screws Included | | |
| | 48202-6062 | Screw Hole, Threaded | | |
| 15 | 48202-6063 | 4-40 Hex Internal Thread Screws Assembled | 15µ" Gold | |
| | 48202-6152 | Screw Hole, Threaded | | |
| | 48202-6153 | 4-40 Hex Internal Thread Screws Assembled | | |
| | 48202-6154 | M2.6 Inner Thread Screws Assembled | | |
| | 48202-6155 | M3 Inner Thread Screws Assembled | | |
| | 48202-6156 | 4-40 Hex Internal Thread Screws Included | | |
| | 48202-6157 | M2.6 Inner Thread Screws Included | | |
| | 48202-6158 | M3 Inner Thread Screws Included | | |
| | 48202-6159 | Screw Hole, Threaded | | |
| 25 | 48202-6362 | 4-40 Hex Internal Thread Screws Assembled | Gold Flash | |
| | 48202-6363 | M2.6 Inner Thread Screws Assembled | | |
| | 48202-6364 | M3 Inner Thread Screws Assembled | | |
| | 48202-6365 | 4-40 Hex Internal Thread Screws Included | | |
| | 48202-6366 | M2.6 Inner Thread Screws Included | | |
| | 48202-6367 | M3 Inner Thread Screws Included | | |
| | 48202-6368 | Screw Hole, Threaded | | |

I/O Products

N

High Density, DDC Compatible D-Subminiature Shielded I/O PCB Receptacle

48203

Female, Right Angle Through Hole

Features and Benefits

- DDC Compatible D-subminiature
- Beveled metal pin provides positive PCB retention
- Metal shell provides EMI/RFI shielding
- Interchangeable with industry-standard receptacles

Reference Information

Product Specification: PS-48203-001
 Packaging: Tray
 Designed in: Millimeters

Electrical

Voltage: 300V DC
 Current: 1.0A
 Contact Resistance: 20 milliohms max.
 Dielectric Withstanding Voltage: 500V DC
 Insulation Resistance: 1000 Megohms min.

Mechanical

Contact Retention Force: 22.49N
 Durability: Gold Flash and 15µ" Gold—600 cycles
 30µ" Gold—1000 cycles

Physical

Housing: Glass-filled polyester, UL 94V-0
 Contact: Phosphor Bronze
 Plating: Solder Tail Area—100µ" Tin
 Underplating: 50µ" Nickel
 PCB Thickness: 1.60mm (.062")

| Circuits | Order No. | Lock to Mating Part | Plating Contact | Lead-free |
|----------|----------------------------|---|-----------------|-----------|
| 15 | 48203-6042 | Screw Hole, Threaded | 30µ" Gold | Yes |
| | 48203-6043 | 4-40 Hex Internal Thread Screws Assembled | 30µ" Gold | |
| | 48203-6056 | 4-40 Hex Internal Thread Screws Included | 15µ" Gold | |
| | 48203-6062 | Screw Hole, Threaded | Gold Flash | |
| | 48203-6065 | M3 Inner Thread Screws Assembled | | |
| | 48203-6763 | 4-40 Hex Internal Thread Screws Assembled | | |
| | 48203-6772 | Screw Hole, Threaded | | |

0.50mm (.020") Pitch Shutter I/O

49045

**Right Angle
SMT, Shielded**

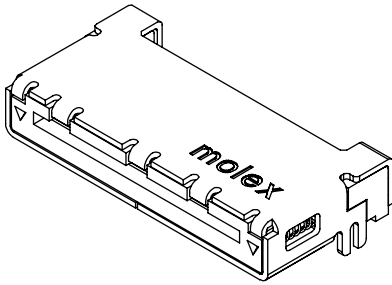

| Circuits | Order No. | Lead-free |
|----------|----------------------------|-----------|
| 24 | 49045-0011 | Yes |

Features and Benefits

- Diecast frame provides strain relief of cable to receptacle and isolates cable loads from SMT tails
- High level of pin-to-PCB compliancy aids coplanarity
- Shielded tab

Reference Information

Product Specification: PS-49045-001

Packaging: Embossed tape

Designed In: Millimeters

Electrical

Voltage: 30V max.

Current: 0.5A max.

Contact Resistance: 50 milliohms max., 100 milliohms max.

Dielectric Withstanding Voltage: 300V AC/1 min.

Insulation Resistance: 1000 Megohms min.

Mechanical

Mating Force: 19.6N max.

Unmating Force: 19.6N max.

Durability: 20,000 cycles

Physical

Housing: PA, UL 94V-0

Contact: Copper Alloy

Plating: Contact Area—Gold

High-Performance Cable Assemblies

Introduction

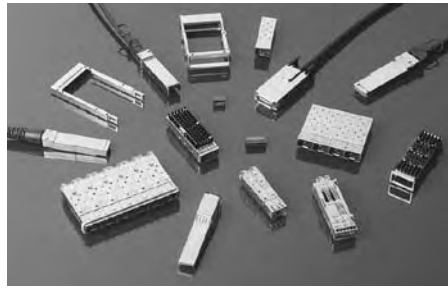

10.0 Gbps Family

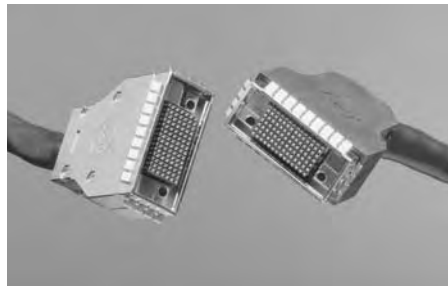

VHDM® High-Performance Cable Assembly



Small Form-factor Pluggable (SFP) Multi-port Cages



iPass™ Connectors and Cable Assemblies for Mini-SAS and Mini-SATA

HIGH LEVEL SUPPORT FOR HIGH-PERFORMANCE CABLE ASSEMBLIES

Developing quality, cost-effective high-performance cable assemblies requires innovation and responsiveness, which is why Molex organized our High-Performance Cable Assemblies Team.

Our interactive, person-to-person environment enables Molex to provide faster response to customer inquiries, as well as develop standard or custom solutions more cost-effectively. The centralized team structure also keeps sales and marketing personnel involved throughout the design and development process for more customer-focused solutions. We routinely conduct cross-functional, “real-life” analysis of designs prior to implementation, which results in more user-friendly products.

Molex Makes Designing High-Performance Cable Assemblies Simple

First we translate your critical design requirements like crosstalk, rise time, skew, impedance, propagation delay, capacitance and attenuation into electrical and mechanical specifications. Then we work with you to determine if one of Molex’s standard interconnect products can be used “as is” or modified to meet your specifications.







If your application truly demands a custom solution, we can design and produce one cost-effectively. Our design engineers can construct computer models and test them with computer-aided electrical simulation (SPICE)—as if they were actual assemblies. Mechanical reliability and durability are calculated using Finite Element and Boundary Element Analysis. These computer programs also make it easy to create physical models and prototypes for testing purposes using Molex’s in-house stereolithography, CNC and EDM systems. Once you approve the final design and prototype, Molex conducts a Process FMEA that eliminates potential failure modes from the proposed tooling design and manufacturing process.

Molex Also Provides Advanced Manufacturing for Your Cable Assemblies

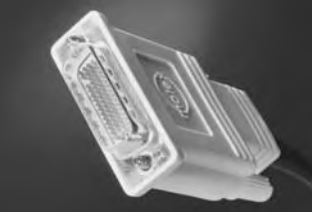
Our production capabilities include computer-controlled laser wire preparation, thermo-resistance welding, ultra sonic welding, induction reflow soldering, hot bar soldering and insert molding. The finished products are subjected to Molex’s stringent quality control processes, including digital/analog electrical testing.

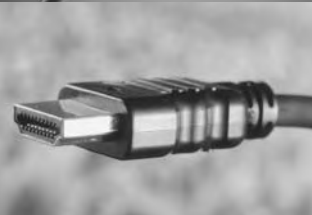



Whether you require only selected services or start-to-finish, turnkey assistance, Molex’s High-Performance Cable Assemblies Team is the right choice. We have the resources and experience to meet your exact requirements and to minimize the time-to-market for your high-performance cable assemblies.

I/O Cable Assemblies

| | <i>Product</i> | <i>Features and Benefits</i> |
|---|---|---|
|  | CradleCon™ | <ul style="list-style-type: none"> • Compact 3.85mm (.152") design to save space • Highly reliable: 10,000 mating cycles • Blind-mating guides to accommodate cradles |
|  | DMS-59™ | <ul style="list-style-type: none"> • Rugged LFH™ contact design provides 2 points of contact for optimal signal integrity and reduces insertion force to ensure high reliability • Keyed by voiding out pin 58 • Meets VESA standard |
|  | HandyLink™ | <ul style="list-style-type: none"> • Receptacles feature a high-temperature thermoplastic housing that withstands lead-free processing • Plugs are offered in both PCB and wire termination versions to provide design flexibility • Robust cradle design with parts offered in both perpendicular or parallel mounting to PCB, which provides optimal design flexibility for all docking applications |
|  | High Definition Multimedia Interface* (HDMI) | <ul style="list-style-type: none"> • Carries uncompressed audio/video in a single cable at speeds up to 5.0 Gbps • Fully shielded for ESD protection • Mounting flange to protect solder joints and to provide additional grounding |
|  | IEEE 1394 IEEE 1394b | <ul style="list-style-type: none"> • Hot-plugging capability • Peer-to-peer connection system which enables a dense multimedia data stream between products at a speed of 400 Mbps for IEEE 1394 and capable of S3200 for IEEE 1394b-2002 • Keyed to eliminate mismatching |
|  | LFH™ | <ul style="list-style-type: none"> • Highly reliable: 5,000 mating cycles • Shielded to protect signal integrity • Low mating force |
|  | MicroCross™ DVI and Adapters | <ul style="list-style-type: none"> • Single and dual-link digital signaling allows for high-speed digital transmission (4.95 or 9.9 Gbps) • Analog coaxial lines allow for high-speed analog transmission (2.5 GHz) • Fully shielded for excellent EMI/RFI performance |

*High Definition Multimedia Interface and HDMI are trademarks of HDMI Licensing, LLC

I/O Cable Assemblies

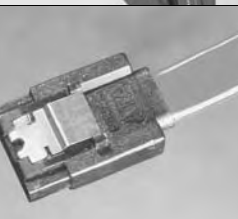
| | <i>Product</i> | <i>Features and Benefits</i> |
|---|---------------------------------------|---|
|  | <p>Modular Plug Assemblies</p> | <ul style="list-style-type: none"> • Short and long body styles available to provide design flexibility for standard applications • Protective strain relief covers available to protect wiring • Variety of circuit sizes and plating options |
|  | <p>Ultra+™ VHDCI</p> | <ul style="list-style-type: none"> • Interface dimensions conform to IEC-48B (SEC) 199 specifications • Blank tuning fork terminal for smooth contact and reliability • IDT plug terminates with discrete wire (28 AWG) or flat ribbon cable (.025 to 30 AWG) |
|  | <p>TDP™</p> | <ul style="list-style-type: none"> • High-cycle LFH™ shrouded contact system provides two points of contact for optimal signal integrity • Fully shielded for excellent EMI/RFI performance • Triad contact configuration optimizes bandwidth |
|  | <p>USB OTG (On-the-Go)</p> | <ul style="list-style-type: none"> • Highly reliable: 5,000 mating cycles • Fully shielded for excellent EMI/RFI performance • Up to 127 different peripherals can be connected to this common interface standard |
|  | <p>SAS Internal</p> | <ul style="list-style-type: none"> • Disk/Backplane Interoperability with SATA—to give flexibility to specify best drive for intended use: SAS for transaction/online performance and reliability, Serial ATA for near line and backup/restore storage • 3.0 Gbps transfer rate—to set new standards for enterprise-class performance, second generation on track for 6.0 Gbps throughput • Compact cabling and connectors—to simplify cable routing, saves space and improves airflow/cooling in system cabinets, connectors easily fit on small form factor devices |
|  | <p>Serial ATA* Internal</p> | <ul style="list-style-type: none"> • Backward compatibility, which means it's compatible with existing ATA software drivers and runs on standard operating systems without modification • Scalability, which provides significant headroom for future enhancements to the computing platform as well as improvements in bandwidth performance and data transmission reliability • Cost effectiveness for greater performance improvement potential with 10 year roadmap; allows performance of internal storage devices to continue to increase unabated for years to come |

*Serial ATA is a trademark of the Serial ATASM Trade Association